



Users Instructions

from **AGA**

Heatranger 440/460/480/499K

For use in GB and IE

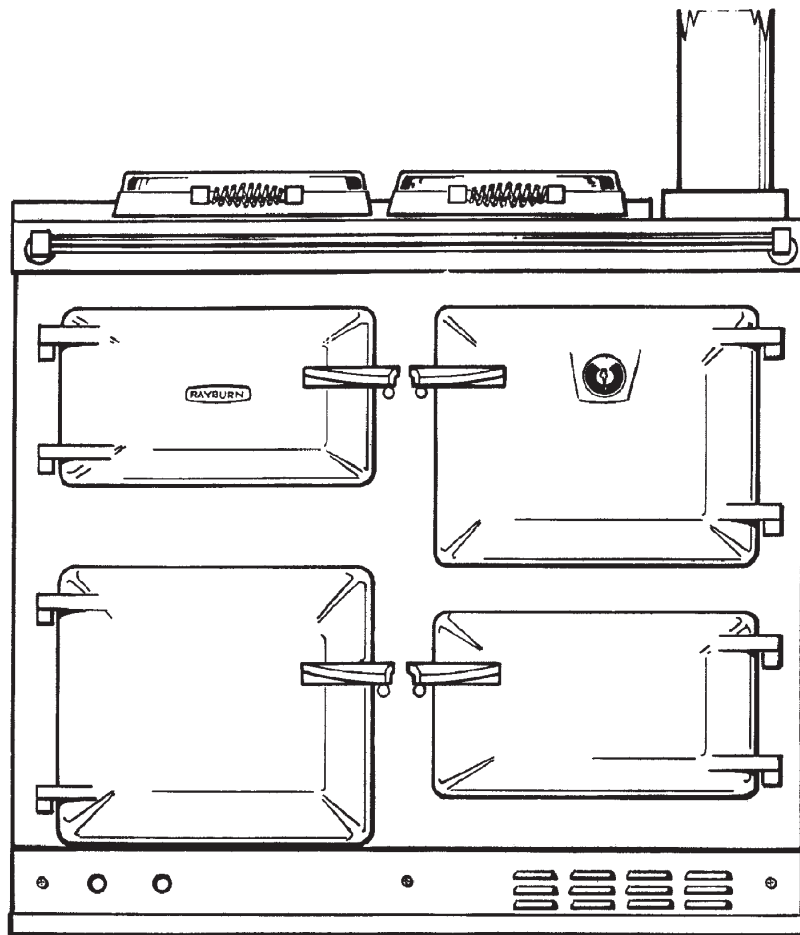

DESN 511593 A

PLEASE READ THESE INSTRUCTIONS BEFORE USING THIS APPLIANCE

| SECTION | PAGE |
|---|-------------|
| INTRODUCTION & USER INFORMATION | 3 |
| CONTROLS | 4 |
| THE COOKER | 5 |
| COOKING HINTS | 6 |
| THE BOILER | 7 |
| THE PROGRAMMER | 8 |
| GETTING STARTED WITH THE PROGRAMMER | 9 |
| SETTING THE DATE AND TIME | 9 |
| RUNNING A BUILT-IN PROGRAMME | 9 |
| CUSTOMISING YOUR PROGRAMMER | 10 - 12 |
| THE BUILT-IN PROGRAMMES | 10 |
| REVIEWING THE PROGRAMME TIMES | 10 |
| MODIFYING THE COOKER PROGRAMME | 11 |
| EXITING THE COOKER PROGRAMMING MODE | 11 |
| MODIFYING THE HEATING PROGRAMME | 12 |
| EXITING THE HEATING PROGRAMMING MODE | 12 |
| DISABLING/ENABLING TIME PERIODS FOR HEATING AND/OR COOKER | 12 |
| OPERATING YOUR PROGRAMMER | 12 |
| CHOOSING THE OPERATING MODE FOR HEATING AND/OR COOKER | 12 |
| OVERRIDING THE OPERATION WITHOUT CHANGING THE PROGRAMMES | 12 |
| THE EXTRA HOUR FUNCTION (FOR HEATING AND/OR COOKER) | 13 |
| HOLIDAY FUNCTION | 13 |
| HOW DO I USE THE OVERRIDE BUTTON | 13 |
| HOW DO I USE THE EXTRA HOUR BUTTON | 13 |
| FINE TUNING YOUR PROGRAMMER | 14 |
| CHANGING FROM AM/PM TIME DISPLAY TO THE 24 HOUR CLOCK | 14 |
| CHANGING THE INSTALLER PARAMETERS | 14 |
| FAQ AND TROUBLESHOOTING | 15 |
| TROUBLESHOOTING GUIDE | 16 |
| CONFIGURATION DATA | 16 |
| CLEANING AND CARING FOR YOUR RAYBURN | 17 |
| BURNER RESET, OIL LEAK OR FAULT, POWER FAILURE, FUEL, VENTILATION AND SERVICING | 18 |

INTRODUCTION

Thank you for buying a Rayburn Appliance. To get the best from it, please read and carefully follow the instructions before using your Rayburn for the first time.

Consumer Protection

As responsible manufacturers we take care to make sure that our products are designed and constructed to meet the required safety standards when properly installed and used.

IMPORTANT NOTICE: PLEASE READ THE ACCOMPANYING WARRANTY.

Any alteration that is not approved by AGA could invalidate the approval of the appliance, operation of the warranty and could affect your statutory rights.

Health and Safety

See Installation and Servicing instructions for details.

The Appliance

Your Rayburn has been designed to provide cooking, central heating and domestic hot water when you require it. It can be run as an on/off cooker.

The boiler side of your Rayburn should not be set to run below 60°C.

If the weather is very cold, or if you prefer, the appliance cooker burner can be run on a continuous low or high setting as required. **Do not use to warm a room with the appliance doors left open.**

DO NOT LEAVE THE ROASTING OVEN DOOR OPEN - If left open for any length of time over-heating may cause damage to some components within the appliance.

This Rayburn is for use with Kerosene C₂ to BS 2869 only.

This appliance must be commissioned by an approved engineer.

A Rayburn programmer is supplied as an integral part of the appliance and allows the cooking and heating functions to be used separately or together.

Two independently fired oil burners are fitted. These are:-

1. The boiler burner which gives domestic hot water and central heating or domestic hot water only, dependent on external controls fitted.
2. The cooker burner gives control of hotplate and oven temperatures.

Your Rayburn comes complete with:-

| | | |
|---------------------|----------------|----------------------------|
| 1 Meat Tin | 1 Grill Rack | 1 Commissioning Letter |
| 1 Solid Shelf | 2 Grid Shelves | 1 Servicing Instruction |
| 1 Wire Brush | 1 Cookbook | 1 Installation Instruction |
| 1 Users Instruction | | |

USER INFORMATION

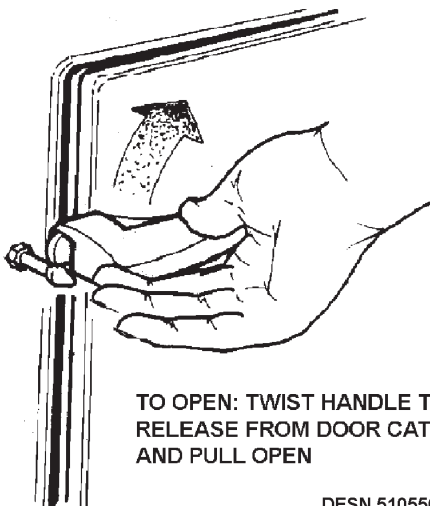

DESN 510556 A

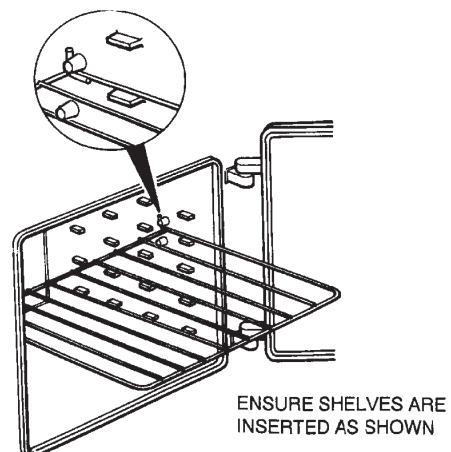

CONTROLS

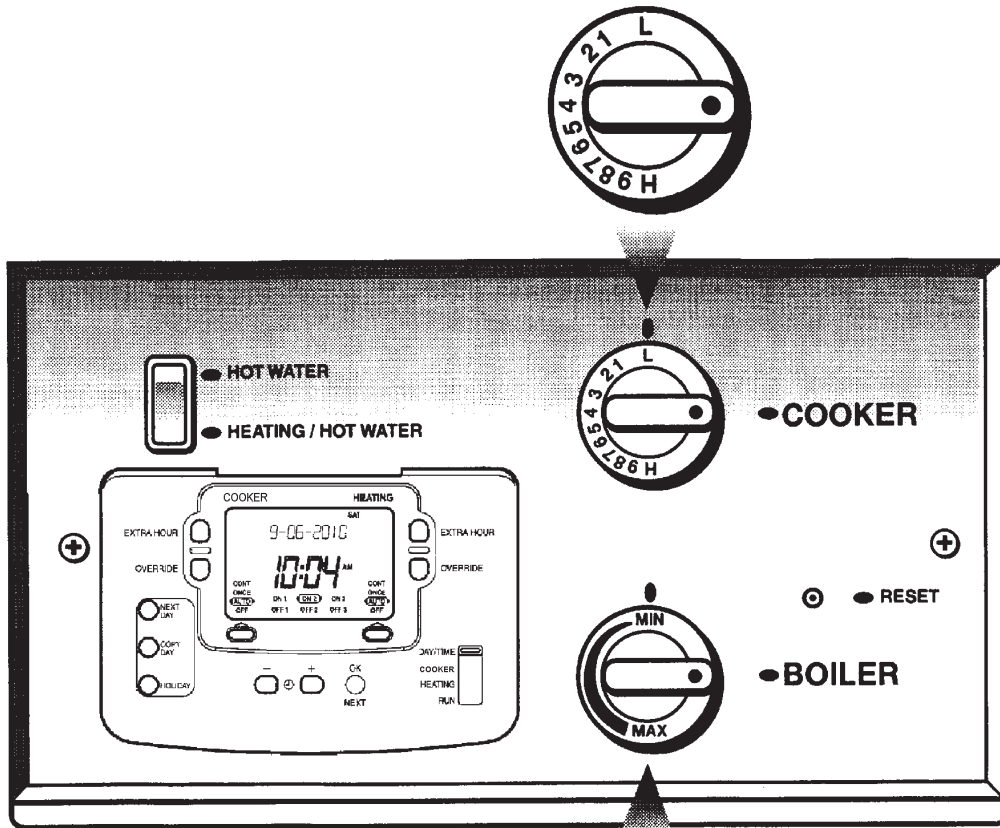

When the cooker control knob is in the vertical park position, the cooker burner may come on if the temperature in the oven is cold enough until the temperature reaches approximately 25°C. To overcome this it is recommended that 'cooker off' is selected on the programmer when not in use.

NB: In the case of a power cut the programmer will default to 'AUTO' mode with default timings when the power is restored. This means that after one hour of the power being restored to the appliance, power will be supplied to the cooker thermostat which may fire the burner even if the cooker control knob is in the vertical park position.

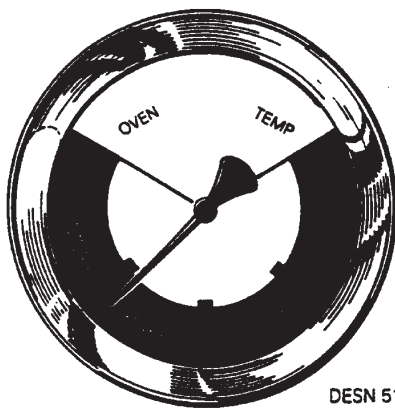

THERMODIAL

DESN 510556

THE THERMODIAL ON THE MAIN OVEN DOOR IS A GUIDE TO THE CENTRE OVEN TEMPERATURE WHEN COOKING SEE COOKING CHART ON PAGE 4 AND COOKING HINTS ON PAGE 5 FOR FURTHER INFORMATION

| MARK | APPROX TEMP |
|------|-------------|
| LOW | 90°C |
| 1 | 140°C |
| 2 | 150°C |
| 3 | 170°C |
| 4 | 180°C |
| 5 | 190°C |
| 6 | 200°C |
| 7 | 220°C |
| 8 | 230°C |
| 9 | 250°C |
| HIGH | 275°C |

THE COOKER

The operation of the cooker is controlled by a built in programmer. It can be operated under automatic or manual control. See section 'PROGRAMMER'.

MAIN OVEN AND HOTPLATE CONTROL

The main oven and hotplate temperatures are controlled by the cooker thermostat control knob which is situated behind the controls door. See section 'CONTROLS' - Page 4.

Turning the control knob clockwise increases the temperature.

THE HOTPLATE

The single hotplate of your Rayburn is graduated in temperature. Just slide pans to a hotter or cooler area depending on whether boiling or simmering is required.

The hottest area is in the middle right hand side.

The hotplate temperature is also variable, depending upon the setting used; the higher the setting then the higher the hotplate temperature.

Made of thick cast iron, the hotplate is machined flat. In order to ensure perfect contact and even heat distribution it is recommended that all pans and kettles used have thick machined flat bases. Pans should also have tight fitting lids for greatest efficiency. Keep the insulated hotplate covers down when the hotplate is not in use to conserve heat.

THE MAIN OVEN

The oven thermostat control knob is marked ● (OFF) then temperature graduated. (See diagram, page 4).

THE LOWER OVEN

The temperature of the cast iron lower oven is dependent on the temperature in the main oven. As a guide it is around half the temperature in the main oven for food such as meringues, casseroles, milk puddings etc. This means that it can be used as a cooking oven when the main oven is at a higher temperature ie. over 200°C (400°F).

If the Rayburn is left on a high setting for a lengthy time the lower oven may climb to a temperature higher than half that of the main oven temperature.

THE RAYBURN COOKBOOK

The cookbook supplied with your Rayburn cooker is common to all Rayburns. When following the recipes consult these operating instructions to ascertain details relevant to your Rayburn.

NOTE: SMOKE/SMELL EMITTED DURING INITIAL USAGE

Some parts of the cooker have been coated with a light covering of protective oil. During initial operation of the cooker this may cause smoke/smell to be emitted and is normal and not a fault with the appliance, it is therefore advisable to open doors and or windows to allow for ventilation. Lift the lids to prevent staining the linings.

COOKING CHART (MAIN OVEN)

| | Temperature | Shelf | Approximate Time |
|-----------------------|-------------------------------|------------------|---|
| Scones | 220°C (425°F) | 3 | 10 - 15 mins |
| Small Cakes | 190°C (375°F) | 4 | 15 - 20 mins (Turn the tray round halfway through cooking. For best results place the solid plain shelf on the top runner) |
| Victoria Sandwich | 180°C (350°F) | 3 + 5 OR 4 | 20 - 30 mins (Move the lower cake up when the top cake is cooked. For best results place the solid plain shelf on the top runner) 20 - 30 mins (Both cakes on one shelf) |
| Semi-rich fruit cake | 150°C (300°F) | 4 or 5 | 2 hours |
| Rich Fruit Cake | 135°C (275°F) | 4 or 5 | Depending on size |
| Shortcrust - tartlets | 200°C (400°F) | 2 or 3 | 20 mins |
| Shortcrust Pie | 200°C (400°F) | 4 or 5 | 45 mins |
| Quiche | 200°C (400°F) - 220°C (425°F) | Floor | 45 mins |
| Puff Pastry | 210°C (410°F) - 220°C (425°F) | 2 or 3 | 15 mins |
| Meringues | 100°C (212°F) - 120°C (240°F) | 5 | 1 1/2 - 2 hours |
| Casseroles | 120°C (240°F) | 4 or 5 | 3 hours or more |
| Bread - rolls | 210°C (410°F) - 220°C (425°F) | 2 | 15 - 20 mins |
| Bread - loaf | 210°C (410°F) - 220°C (425°F) | 4 or 5 | 35 mins |
| Soufflé | 180°C (350°F) | 4 | 30 mins |

Shelf positions are counted downwards ie: top shelf position is number 1.

The positions are a guide only and can of course be altered to suit.

COOKING HINTS

The ovens are indirectly heated from the outside by hot gases from the heat source so that no flame or elements are within the ovens. This means that full use can be made of the whole cooking space. Both ovens are vented to the flue so cooking smells disappear to the outside.

MAIN OVEN

This oven is hotter towards the top than the bottom.

For perfect results turn food during cooking.

On low settings the oven can be used for long slow cooking such as casseroles, stock, soup, ratatouille, curries, meringues, creme caramel, rice pudding, etc. Turn up to a higher setting for baking fruit cakes, victoria sandwiches, small cakes, soufflés, scones, bread and roasting etc. (See temperature/setting chart on previous page for details).

One of the many benefits of the cast iron oven is that the floor of the oven is hot and can be used as a cooking area in its own right.

1. For Baking - no need to bake pastry case or quiche "blind" just place the flan dish directly on the oven floor for the whole, or part of, the cooking time to achieve "soggy-free" pastry bases that are crisp and golden. In the same way an apple pie can be part cooked on the oven floor to ensure a well cooked base.
2. For Frying - when the oven is hot the floor of the oven can be used for frying. Think of it as a hidden hot plate. A cast iron dish is recommended. Allow it to heat up first before adding the food. It's an excellent method for frying bacon and egg, fish such as trout/salmon or onions etc. Any fat splashes are carbonised on the insides of the oven so cleaning is minimal (carbonised crumbs can be brushed out using a stiff brush) and frying smells are taken away through the flue.

The top of the oven is where the grilling takes place. Do this when the oven is turned up to a high setting. The heat radiating from the roof of the oven seals and cooks the food efficiently. Arrange the food on the grill rack in the meat tin set on the highest set of runners.

Cast iron retains the heat so you can peep at a cake or soufflé to see how it is cooking without it sinking. As the meat tin supplied with your Rayburn fits directly on to the runners the grid shelves are left free for other dishes. For safety reasons the grid shelves are non-tilt, use as directed in section 'USER INFORMATION' page 2.

THERMODIAL

The thermodial on the main oven door is a guide to the condition of the internal oven. On opening, the pointer will appear to drop as it registers cooler air away from the oven, do not worry, close the door and after a few minutes it will regain its position.

LOWER OVEN

A valuable oven for slower more gentle cooking when the main oven is turned up high, as it is roughly half the temperature of the main oven. Ideal for meringues, casseroles, milk puddings, egg custards etc. When cooking a casserole in this oven allow it to heat through and simmer for 5-10 minutes on the hotplate or main oven floor before transferring to the lower oven. Although there are runners on the sides of the oven for the grid shelf/meat tin, dishes may also be cooked on the floor of the oven.

SOLID SHELF

The solid shelf can be used as a baking sheet or as a heat deflector to protect food from over browning/cooking. It is ideal as a solid baking sheet as it maximises the whole oven area. When in position the solid shelf and the space above can still be used for cooking, while it is protecting the food below. As a heat deflector slide it in two runners above the food. To be effective it must be used from cold and therefore it should be stored outside the oven.

HOTPLATE

Apart from its obvious use for boiling and simmering, the hot plate can be used directly, for making toast, toasted sandwiches, drop scones, see the Rayburn cookbook for details. After cooking directly on the hotplate make sure you brush off any crumbs or this could impair the boiling performance of the kettle or sauce pans.

ACCESSORIES

Further accessories, tin, shelves, solid shelves, saucepans, apron and gauntlets, etc are available from your Rayburn Stockist.

LOCATION OF GRID SHELVES

To ensure the correct operation of the oven grid shelves, ensure that they are inserted as shown. (See section 'USER INFORMATION') - page 3.

DOORS

To open the doors. Twist the handle slightly to disengage the door catch from the locking spindle and pull door open (See section 'USER INFORMATION') page 3.

To close the doors. Gently push the door shut until the door catch engages with the locking spindle.

IT IS NOT ADVISABLE TO PUT VERY WET CLOTHES OR TOWELS ONTO THE HANDRAIL, AS THIS MAY CRAZE THE ENAMEL.

THE BOILER

The operation of the boiler is controlled by the built-in programmer, it can be operated under automatic or manual control. See section 'PROGRAMMER'.

The temperature of the hot water supplied can be adjusted by means of the boiler thermostat knob. This knob can also be used to turn the boiler off.

To inhibit internal corrosion of the boiler heat exchanger it is important not to operate the boiler below 60°C. An ideal setting for summer hot water; and to keep the temperature above 60°C, can be achieved with a thermostat knob setting midway between MAX and MIN.

The boiler thermostat knob is situated behind the control door (See Fig. 1). Turn the knob clockwise to increase the temperature of the water.

For safety purposes an overheat thermostat is fitted. This thermostat is a safety cut-out device which intended to operate if other controls fail. This control will "Lock-out" and switches everything off except for the programmer and the "pump overrun" facility.

This thermostat has to be manually reset once the temperature has cooled down.

Should your heating/hot water system be of an unvented design i.e. Pressurised System. It is important not to keep resetting the boiler safety cut-out as this may indicate a loss of secondary water. Check also your system pressure gauge.

To reset press the centre of the reset button (See Fig. 1) with a small probe (pencil, ball point et).

In the event of repeated failure switch off oil and electrical supply to the appliance and contact your installer/service engineer.

HOT WATER/HEATING AND HOT WATER SWITCH SEE FIG.1

Switch up to
'HOT WATER' - When hot water only is required.
(SUMMER USE)

Switch down to
'HEATING/HOT WATER' - When both central heating (USUALLY WINTER USE) and hot water is required.

NOTE: Some heating systems may have been installed with a programmable room thermostat or additional external controls, in which case this switch is inoperative. Please check with your installer

FROST PRECAUTIONS

In the event of the boiler being OFF for long periods during very cold weather, the advice of your installer should be obtained.

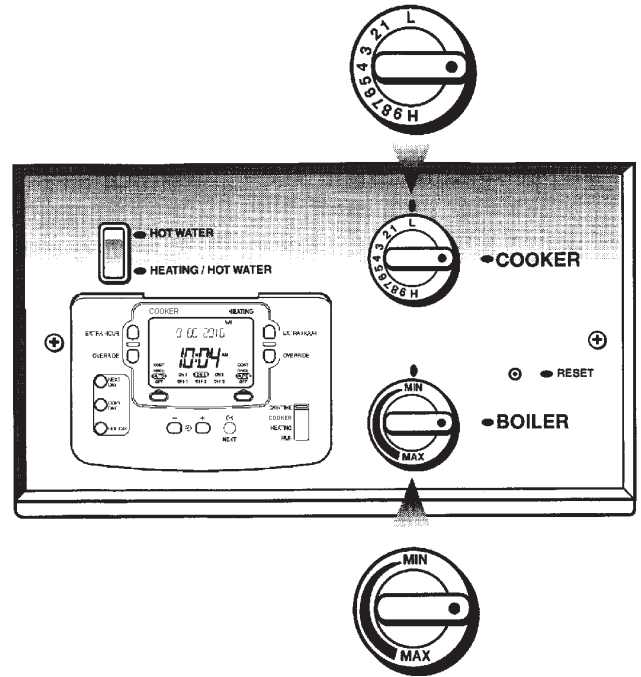

Fig. 1

DESN 516074

THE PROGRAMMER

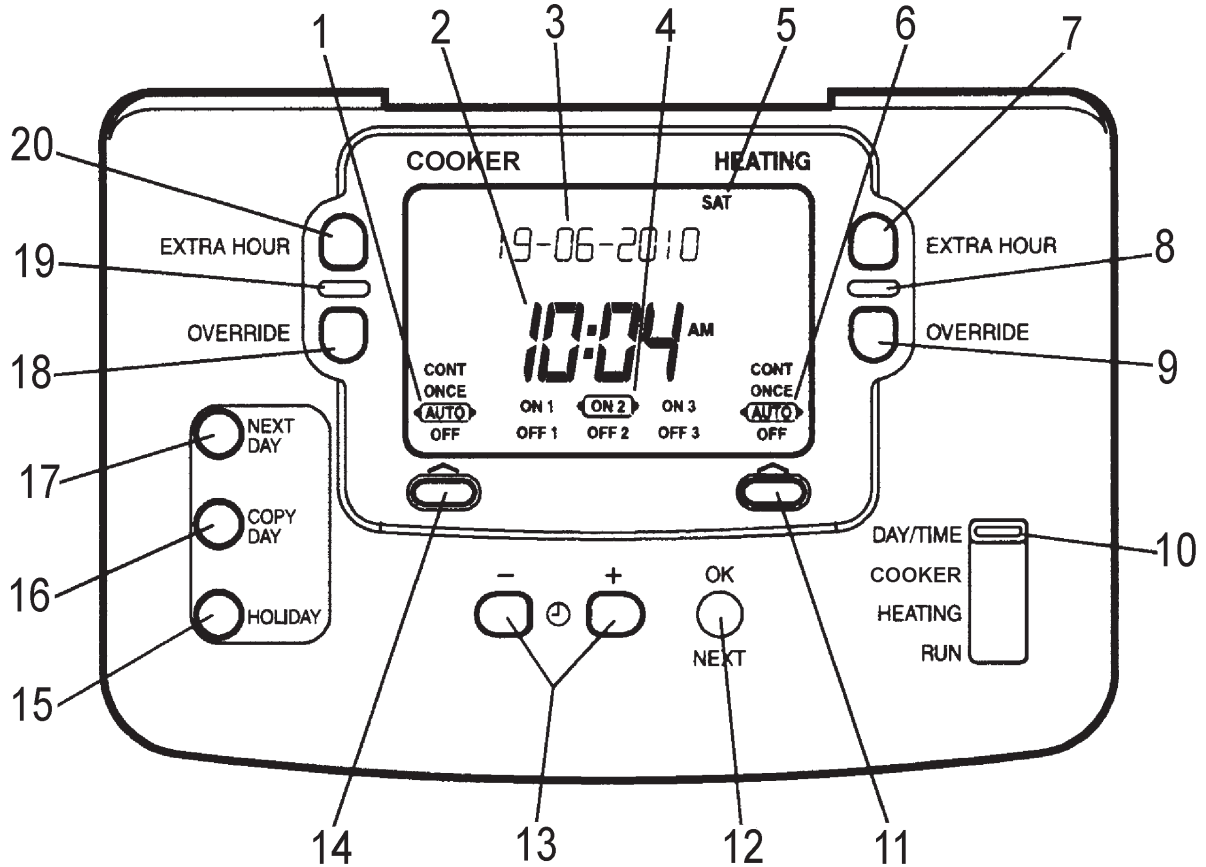

Fig. 2

DESN 516075

Controls

- | | |
|-------------------------------------|-----------------------------------|
| 1. Cooker Operating Mode Indicator | 11. Heating Operating Mode Button |
| 2. Time Display | 12. OK/Next Button |
| 3. Electronic Display | 13. Clock - and + Buttons |
| 4. Programme Time Markers | 14. Cooker Operating Button |
| 5. Day of Week Indicator | 15. Holiday Button |
| 6. Heating Operating Mode Indicator | 16. Copy Day Button |
| 7. Heating Extra Hour Button | 17. Next Day Button |
| 8. Heating Indicator Lamp | 18. Cooker Override Button |
| 9. Heating Override Button | 19. Cooker Indicator Lamp |
| 10. Slider | 20. Cooker Extra Hour Button |

General Description

The programmer provides timing control for both the cooker and hot water system, letting you set **ON** and **OFF** periods to suit your lifestyle.

With 7-day programming and up to 3 on/off periods per day, every day can be set differently, and heating and cooking can be set at different times from each other.

Features available on the programmer are **OVERRIDE**, **EXTRA HOUR**, and **MODE** buttons.

A typical use of **OVERRIDE** feature is when you return home unexpectedly for the rest of the day and the heating is off. Just press the **OVERRIDE** button and the heating will come on until the next programme time, at which point it will follow the normal programme. The advantage is that you do not have to remember to switch off because the normal time programme does this for you.

A typical use of the **EXTRA HOUR** button would be if you returned home for a short period when the heating and cooking were off. Pressing the appropriate **EXTRA HOUR** button gives 1, 2 or 3 hours of heating, exactly when you need it. Another use is when the heating is already on and you want it to stay on a little longer - just press **EXTRA HOUR** and, for that day only, an hour will be added to the end of the time at which heating normally goes off.

The **MODE** buttons allow you to select how you want to operate heating and cooking independently. The most obvious use is to switch heating **OFF** during the summer months, but you may also use this feature if you take a mid-week day off work, you can then set the **MODE** to **ONCE** to keep the system **ON** during the day from the first programmed **ON** time till the last programmed **OFF** time.

GETTING STARTED WITH THE PROGRAMMER

The programmer comes pre-set with default times. However, the following will show you how you can modify the settings to suit your lifestyle.

Step 1: Setting the Date and Time

Reset the date or time, or if the display shows the message 'SET DATE + TIME' just follow the instructions below. Otherwise, go to **Step 2**.

- Move the slider to the **DAY/TIME** position. The message 'SET DATE + TIME' will show briefly on the screen, followed by 'SET THE DAY', and the day of the month will now be flashing to indicate it can be changed.
- To change the day of the month, press the **(+)** or **(-)** buttons until the correct day is shown. Each press of the button will change the date by one day. As soon as a change has been made, the message 'IS DAY OK?' will be displayed. Once the correct day is

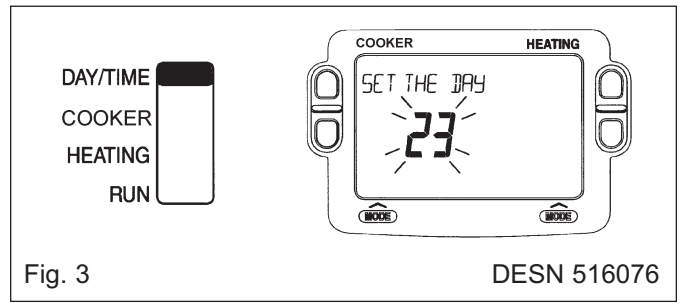

Fig. 3

DESN 516076

reached, press the green **(OK)** button to confirm, and move to the next step. If you do not need to make a change, just press the **(OK)** button immediately and this will move you to the next step.

- The month digits will now be flashing and 'SET THE MONTH' will be displayed. To change the month, press the **(+)** or **(-)** buttons until the correct month is shown. The message 'IS MONTH OK?' will be displayed. Press the green **(OK)** button to confirm the month is correct, and move to the next step.
- The year digits will now be flashing and 'SET THE YEAR' will be displayed. To change the year press the **(+)** or **(-)** buttons until the correct year is shown. The message 'IS YEAR OK?' will be displayed. Press the green **(OK)** button to confirm the year is correct. If you have made a change, and the date is a valid date, the message 'DATE SAVED' will show, and you can move to the next step. If the date you set was not valid, for example 31 September, the message 'INVALID' will show and you will be returned to the start of the date setting operation.
- The time will now be flashing and the message 'SET THE TIME' will be displayed. To change the time, press the **(+)** or **(-)** buttons until the correct time is shown. Each press of the button will change the time by one minute. Holding the button down for more than a few seconds will change the time slowly at first, then quickly. The message 'IS TIME OK?' will be displayed. Press the green **(OK)** button to confirm the time is correct. If you have made a change, the message 'TIME SAVED' will show, followed quickly by 'DATE + TIME COMPLETE'.
- Move the slider to the **RUN** position, to complete setting the date and time.

NOTE: If the slider is moved at any time before the date and time have been set correctly, the message 'DATE UNCHANGED' will be displayed briefly, and your changes will not be saved.

Step 2: Running a Built-in Programme

With the date and time correct, the programmer will now be operating to the built-in programme. These have been designed to provide heating and cooking at typical times throughout the day, but if you want to customise the settings, please see the next section '**CUSTOMISING YOUR PROGRAMMER**' (Pages 10-14).

CUSTOMISING YOUR PROGRAMMER

The Built-In Programmes

The built-in programmes give you a starting point that you can personalise to your own requirements. Your installer should have selected one and ticked the box alongside it. If there is no tick, the product normally leaves the factory with Profile A installed, but it is a simple matter to select one of the other profiles (see **Changing the Installer Parameters**, Page 14)

Built-in Programme (Profile A)

| | | ON 1 | OFF 1 | ON 2 | OFF 2 | ON 3 | OFF 3 |
|------------------------------|----------------|---------|---------|----------|---------|---------|----------|
| Monday to Friday | Heating | 6.30 am | 8.30 am | 12.00 pm | 1.00 pm | 4.30 pm | 10.30 pm |
| | Cooking | 6.30 am | 8.30 am | 12.00 pm | 1.00 pm | 4.30 pm | 10.30 pm |
| Saturday & Sunday | Heating | 6.30 am | 8.30 am | 12.00 pm | 1.00 pm | 4.30 pm | 10.30 pm |
| | Cooking | 6.30 am | 8.30 am | 12.00 pm | 1.00 pm | 4.30 pm | 10.30 pm |

Built-in Programme (Profile B)

| | | ON 1 | OFF 1 | ON 2 | OFF 2 | ON 3 | OFF 3 |
|------------------------------|----------------|---------|---------|----------|---------|---------|----------|
| Monday to Friday | Heating | 6.30 am | 9.30 am | 12.00 pm | 1.00 pm | 4.30 pm | 11.00 pm |
| | Cooking | 6.30 am | 9.30 am | 12.00 pm | 1.00 pm | 4.30 pm | 11.00 pm |
| Saturday & Sunday | Heating | 6.30 am | 9.30 am | 12.00 pm | 1.00 pm | 4.30 pm | 11.00 pm |
| | Cooking | 6.30 am | 9.30 am | 12.00 pm | 1.00 pm | 4.30 pm | 11.00 pm |

Built-in Programme (Profile C)

| | | ON 1 | OFF 1 | ON 2 | OFF 2 | ON 3 | OFF 3 |
|------------------------------|----------------|---------|---------|----------|----------|---------|----------|
| Monday to Friday | Heating | 6.30 am | 7.30 am | 12.00 pm | 12.00 pm | 5.00 pm | 10.00 pm |
| | Cooking | 6.30 am | 7.30 am | 12.00 pm | 12.00 pm | 5.00 pm | 10.00 pm |
| Saturday & Sunday | Heating | 8.30 am | 9.30 am | 12.00 pm | 1.00 pm | 5.30 pm | 10.30 pm |
| | Cooking | 8.30 am | 9.30 am | 12.00 pm | 1.00 pm | 5.30 pm | 10.30 pm |

Your Personal Programme

The table below has been left blank for you to record your own personal programme.

| | | ON 1 | OFF 1 | ON 2 | OFF 2 | ON 3 | OFF 3 |
|------------------|----------------|------|-------|------|-------|------|-------|
| Monday | Heating | | | | | | |
| | Cooking | | | | | | |
| Tuesday | Heating | | | | | | |
| | Cooking | | | | | | |
| Wednesday | Heating | | | | | | |
| | Cooking | | | | | | |
| Thursday | Heating | | | | | | |
| | Cooking | | | | | | |
| Friday | Heating | | | | | | |
| | Cooking | | | | | | |
| Saturday | Heating | | | | | | |
| | Cooking | | | | | | |
| Sunday | Heating | | | | | | |
| | Cooking | | | | | | |

Reviewing the Programme Times

To review your cooking programme, move the slider to the **COOKER** position.

To review your heating programme, move the slider to the **HEATING** position.

To review the programme times, press the **OK** button repeatedly. The appropriate **ON** and **OFF** markers will be displayed to show you which time is being reviewed. Any of these times can be adjusted by using the **⬇️** **+** or **⬆️** buttons, and then confirmed using the **OK** button. Remember to return the slider to the **RUN** position after reviewing is complete

Modifying the Cooker Programme

The cooker programme has three pairs of **ON/OFF** switching times per day. Each time can be set between 3.00 am and 2.50 am (on the next day) to allow you to programme the cooker to stay on past midnight, if required.

- a. Move the slider to the **COOKER** position. 'SET COOKER' will show briefly to verify this action.

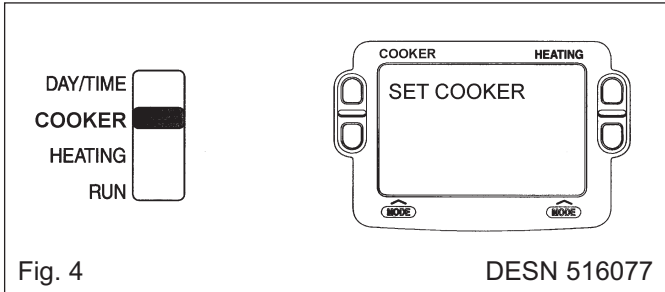

- b. 'SET ON TIME 1' will then be displayed and the setting for the first **ON 1** time for **MONDAY** will now be flashing to indicate it can be changed. If you do not wish to change the time, press the green **OK** button and move to the next step. If you do wish to make a change, use the **+** or **-** buttons to change the first **ON 1** time. Each press of the button will change the time by 10 minutes. As soon as the time has been changed, the message 'ON-TIME 1 OK?' will be displayed. Press the green **OK** button to confirm the time is correct and move to the next step. 'SAVED' will be displayed for a moment to confirm that any change has been saved to memory.

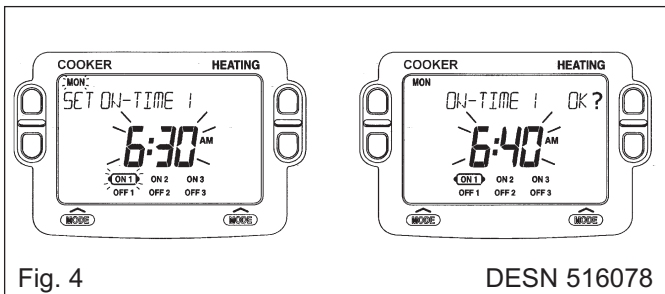

NOTE: When pressing the **+** button the next **ON** or **OFF** marker may start to flash. This indicates you have tried to set a time equal to one of the next programme times already in the memory. Similarly, when pressing the **-** button the previous **ON** or **OFF** marker may start to flash. This indicates you have tried to set a time equal to one of the previous programme times. If this happens the programmer simply moves both times together as long as you continue to press the **+** or **-** buttons. Follow the procedure in 'Reviewing the Programme Times' (see Page 10) to check and adjust these times as necessary.

- c. 'SET OFF-TIME 1' will be displayed and the first **OFF 1** time will now be flashing. If you do not wish to change the time, press the green **OK** button and move to the next step. Otherwise, use the **+** or **-** buttons to change the time. Press the green **OK** button to confirm the time is correct and move to the next step. 'SAVED' will be displayed for a moment to confirm that any change has been saved to memory.

- d. The remaining **ON** and **OFF** times (ON 2, OFF 2, ON 3, OFF 3) can be set by using the **+** or **-** buttons to change the time, and the green **OK** button to confirm the time is correct and move to the next step. If you do not wish to change the time, just press the green **OK** button to move directly to the next **ON/OFF** time without making any changes.
- e. After setting or reviewing the last off time, **OFF 3**, the message 'COMPLETE' will be displayed to indicate the times for Monday have been set.

You now have a choice of how to set the programme for the next day:

Copying one day's Programme to another (example Monday to Tuesday):

- f. Whilst the day is showing Monday. Press the **COPY DAY** button. The message 'COPY MON TO TUESDAY OK?' will be displayed and the letters **TUE** will flash to indicate the programme for Monday can be copied to Tuesday.
- g. To select a different day to copy, press the **NEXT DAY** button to cycle through the days. With each press of the **NEXT DAY** button the message will change to indicate the new day you are copying to.
- h. When the required day is indicated, press the green **OK** button to confirm, and the message 'MON COPIED' will be displayed for a moment. The day into which Mondays programme has been copied is now available to have its programme edited.

NOTE: Once a day's programme has been confirmed in this way, it now becomes the day whose programme is copied if the **COPY DAY** button is pressed again.

OR

Programming a Different Day:

- i. Press the **NEXT DAY** button to select the next day, which is displayed along the top of the screen. The programme for that day can then be adjusted by following steps **b - e** above. Programmes for the remaining days can be set in the same way, using the **NEXT DAY** button to move to the next day.

Exiting COOKER Programming Mode

To exit **COOKER** programming mode, move the slider to the **RUN** position. This can be done at any time during the programming process, and any changes made and confirmed with the **OK** button will have been saved.

NOTE: If the unit is left in **COOKER** Programming mode for more than 10 minutes without the slider being moved, or any buttons pressed, the message 'MOVE SLIDER' will be displayed. Press a button to finish programming, or to move the slider to the **RUN** position.

Modifying the HEATING Programme

The heating programme has three pairs of **ON/OFF** switching times per day. Each time can be set between 3.00 am and 2.50 am (on the next day) to allow you to programme the heating to stay on past midnight if required.

- a. Move the slider switch to the **HEATING** position. 'SET HEATING' will show briefly to verify this action.

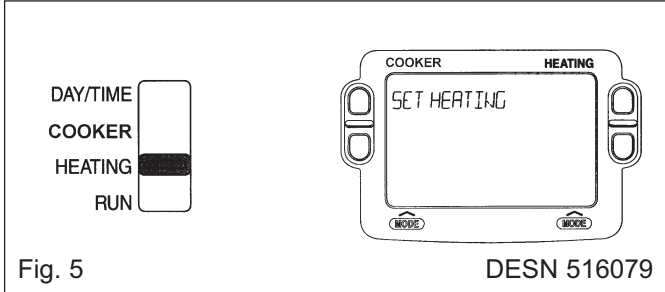

- b. Now follow the same procedure to set the times as described in 'Modifying the Cooker Programme' (Page 11), Steps b. to i.

Exiting HEATING Programming Mode

To exit **HEATING** programming mode, move the slider to the **RUN** position. This can be done at any time during the programming process, and any changes made and confirmed with the **OK** button will have been saved.

NOTE: If the unit is left in **HEATING** Programming mode for more than 10 minutes without the slide being moved or any buttons pressed, the message 'MOVE SLIDER' will be displayed. Press a button to finish programming, or move the slider to the **RUN** position.

Disabling/Enabling Time Periods (for Heating and/or Cooker)

To disable any of the time periods **ON 1** to **OFF 1**, **ON 2** to **OFF 2**, or **ON 3** to **OFF 3**, simply set the **ON** times and its paired **OFF** time to the same time, and the programme will just ignore them.

To re-enable the time period, simply set the two **ON** and **OFF** times to be different.

OPERATING YOUR PROGRAMMER

Choosing the Operating Mode (for Heating and/or Cooker)

The operating mode may only be changed when the slider is set to the **RUN** position.

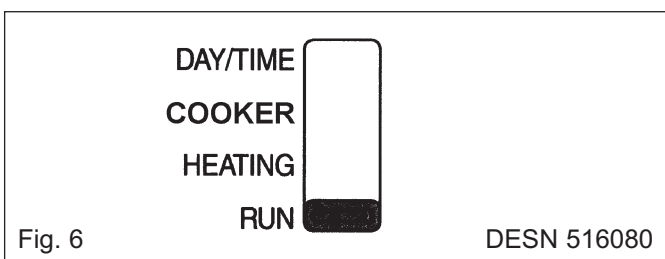

A green **INDICATOR LAMP** shows when the heating or or cooker is switched **ON**.

Two **MODE** buttons are provided to select the Operating Mode and therefore how the heating and cooker are controlled.

Heating has four possible **Operating Modes**; these are **OFF**, **AUTO**, **ONCE**, **CONT**. Pressing the heating **MODE** button scrolls round these modes in sequence, and the display indicates which mode is currently active.

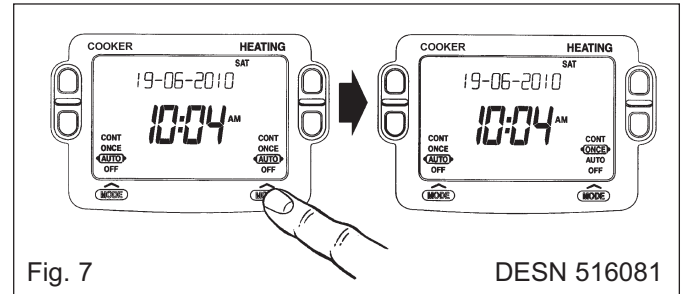

- **OFF Mode**
The heating will remain **OFF**.
- **AUTO (Automatic) mode**
The heating will be switched **ON** and **OFF** according to the heating programme.
- **ONCE mode**
The heating will come **ON** at the first programme **ON** time, and go **OFF** at the last programmed **OFF** time.
- **CONT (Continuous) mode**
The heating will remain **ON** continuously.

The cooker **MODE** button operates in the same way as described above for the heating **MODE** button.

Overriding the Operation Without Changing the Programmes

In **AUTO** and **ONCE** operating modes, the **OVERRIDE** buttons switch the heating or cooker **ON** or **OFF** without altering programme.

When the indicator lamp is **ON**, pressing the **OVERRIDE** button switches the heating or cooker **OFF** until the next programmed **ON** time.

When the indicator lamp is **OFF**, pressing the **OVERRIDE** button switches the heating or cooker **ON** until the next programmed **OFF** time.

The Electronic Display will provide you with information about the override.

The Extra Hour Function (for Heating and/or Cooker)

The **EXTRA HOUR** buttons allow you to switch the heating or cooker **ON** for up to 3 extra hours without altering the programme. Pressing either button once will give one extra hour. The Electronic Display will display the message '+ 1 hour', to confirm the button has been pressed.

When the green **INDICATOR LAMP** is **OFF**, pressing an **EXTRA HOUR** button switches the heating or cooker **ON** for just one hour.

Further presses of the **EXTRA HOUR** buttons will increase the extra hour period by one hour for each button press, up to a maximum of 3 hours. The Electronic Display will continue to provide information on the extra hour status.

To cancel the extra hours, just keep pressing the **EXTRA HOUR** button until the 'CANCELLED' message appears on the display.

The Holiday Function

The Holiday Function allows you to switch off your heating and cooker for a specified number of days (from 1-99 days). This lets you save energy and related costs when you are away from home, but resumes normal operation on the day of your return.

To set the Holiday Function

- Ensure the slider is in the **RUN** position, then press the **HOLIDAY** button once. The message 'SET HOLIDAY' will appear briefly, followed by 'SET DAYS AWAY'.
- Use the **+** or **-** buttons to set the number of days you will be away. The display will show the number of days, and this number will be flashing to indicate it can be changed. The day of the week will also keep changing to show the day you return.
- If you have made a change to the number of days, the message 'DAYS AWAY OK ?' will appear. Press the green **OK** button to confirm your selection.
- The message 'SAVED' will be displayed for a few seconds, followed by the date you return, to enable you to check you have programmed the holiday function correctly.
- During the holiday period, the Electronic Display will show the message 'ON HOLIDAY' and the display will count down the number of days till you return.

To cancel the Holiday Function

- To cancel the Holiday Function, just press the **HOLIDAY** button again. The Electronic Display will show 'CANCELLED' and the unit will return to normal operation.

NOTE: While setting the Holiday function, if there is a gap or more than 1 minute between button presses, this function will cancel itself automatically and return to normal operation.

How do I use the OVERRIDE buttons?

There are two **OVERRIDE** buttons, one for Heating and one for Cooker (see Fig. 8).

To turn the cooker on and override the set programme press the **COOKER OVERRIDE** button marked in Fig. 8. The indicator light will light up to confirm the Cooker is **ON**.

To turn the cooker off again press the **OVERRIDE** button.

Alternatively the next time the programmer is set to switch on or off the override will be cancelled.

The **OVERRIDE** button will only work in the **AUTO** and **ONCE** modes. It will **NOT** work in the **OFF** or **CONT** modes. To change the mode press the button marked 'A' for Cooker and 'B' for Heating in Fig. 8. Each time you press the button it will move through the list of modes above it.

To override the Heating, follow the same instructions as above but with the Heating override button marked in Fig. 8.

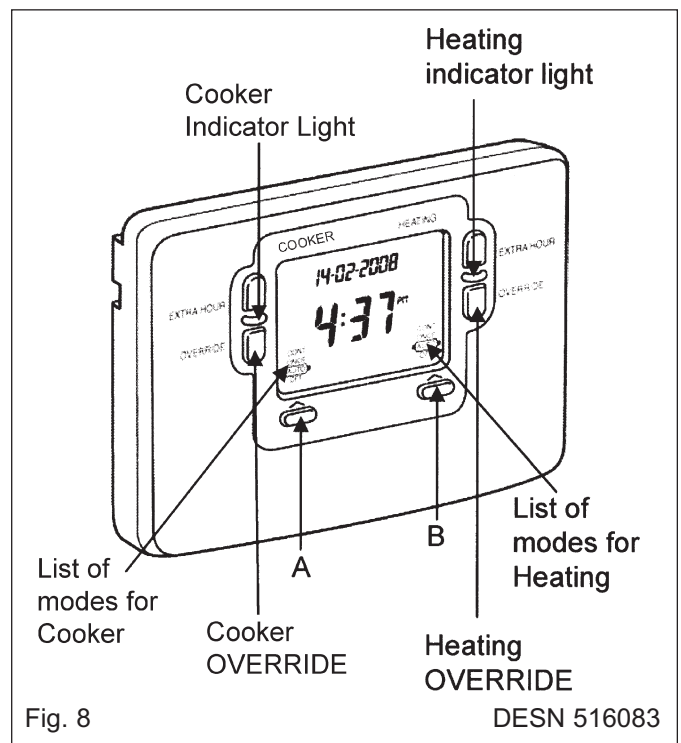

How do I use the EXTRA HOUR buttons?

There are two **EXTRA HOUR** buttons, one for Heating and one for Cooker (See Fig. 9).

Press the button once to bring the Heating or Cooker on for 1 hour. Press the button a second time to bring them on for 2 hours and a third for 3 hours. To turn the override off press the button a fourth time.

The **EXTRA HOUR** button will only work in the **AUTO**, **ONCE** and **OFF** modes. It will **NOT** work in the **CONT** mode. To change the mode, press the button marked 'A' for Cooker and 'B' for Heating in Fig. 8. Each time you press the button it will move through the list of modes above it.

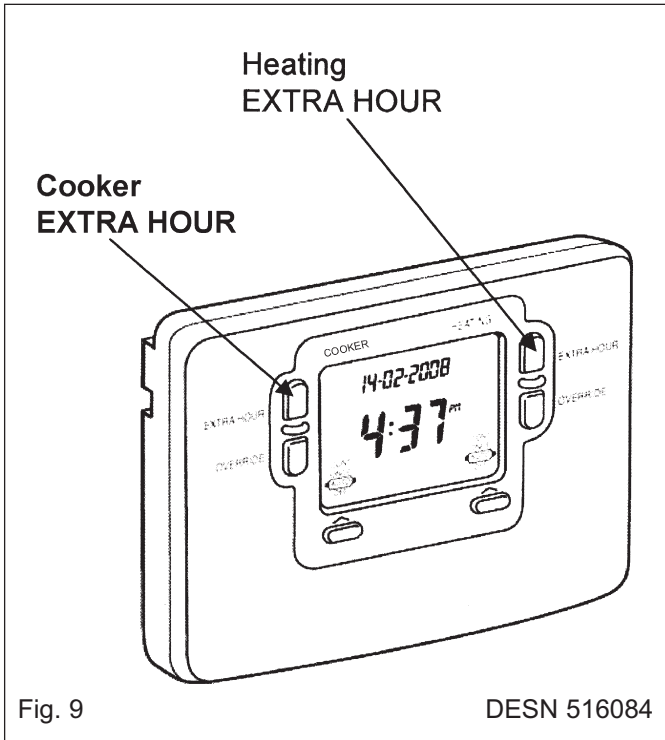

Fig. 9

DESN 516084

FINE TUNING YOUR PROGRAMMER

Changing from AM/PM Time Display to the 24 Hour Clock

Your programmer can operate on the 12 hour AM/PM or 24 hour clock formats. To change the format, ensure the slider is in the **RUN** position and then press and hold the **(+)** and **(-)** buttons together for about 2 seconds. Ignore the 'NOT VALID' message that will appear briefly. All the displayed times will be automatically changed to the new format.

Repeating this procedure will change the clock display back to the original format.

Changing the Installer Parameters

The programmer has a special Installer Mode where some features can be adjusted to suit your lifestyle or preferences - these are called Installer Parameters, and are listed in the table overleaf, along with a description of the options that are possible.

To Enter Installer Mode

a. Ensure the slider is in the **RUN** position, then press and hold **(OK)** and **(-)** buttons together for 8 seconds. Ignore the 'NOT VALID' message that is displayed for a few seconds. The message 'SET UP MENU' will show briefly, followed by 'SET INSTALLER OK?'.

- b. Press the **(OK)** button to take you into the Installer Mode Parameter Menu.
- c. Parameter 1 is now available to change. This is to allow you to change the clock format from 12 hour AM/PM to 24 hour. At every step the Electronic Display will inform you what the parameter means and what option you have selected.

The parameter number is shown on the display separated by a colon from the parameter value.

- d. You can change the parameter value by pressing the **(+)** or **(-)** buttons. At this point the description in the Electronic Display will change and the parameter value will flash. If you press **(OK)** the value will stop flashing and be saved for use.
- e. Press **(OK)** to move to the next parameter available for editing.
- f. Keep pressing **(OK)** to step around the list of parameters, and use **(+)** or **(-)** buttons to change the parameter value.
- g. Any parameter changes that have been confirmed with the **(OK)** button will be saved and used.

To Exit Installer Mode

- h. You can exit Installer Mode at any time by moving the slider to the next position and then back again to **RUN**.

NOTE: The Installer Mode will exit automatically after 10 minutes if the slider is not moved.

| INSTALLER PARAMETER | Parameter Number | Default Value | Options | Description |
|-------------------------------------|------------------|---------------|---------|---|
| 24 hr or am/pm clock display | 1 | 12 | 12, 24 | 12 = am/pm display 24 = 24hr display |
| Configure backlight operation | 2 | 2 | 0, 1, 2 | 0 = off 1 = on if button is pressed 2 = on continuously |
| Enable/disable auto time change | 3 | 1 | 0, 1, | 0 = disabled 1 = enabled |
| 1-day or 5/2 day or 7-day operation | 4 | 7 | 1, 5, 7 | 1 = 1-day operation, 5 = 5/2-day operation, 7 = 7-day operation |
| Number of ON/OFFs per day | 5 | 3 | 2, 3 | 2 = 2 on/off's per day, 3 = 3 on/off's per day |
| Select default time programme | 6 | A | A, b, C | A = standard, b = at home C = Economy |
| Reset all parameters | 8 | 1 | 0, 1 | 0 = do not reset 1 = default parameters |

FAQ AND TROUBLESHOOTING

How do I set the time only, if the programmer clock is not correct?

Your programmer contains a very accurate digital clock that is factory pre-set. Should you ever need to change the time just follow this procedure:

- a. Move the slider to the **DAY/TIME** position.
- b. Keep pressing the green **OK** button until the message 'SET THE TIME' is displayed. To change the time, press the **+** or **-** buttons until the correct time is shown. The message 'IS TIME OK?' will be displayed. Press the green **OK** button to confirm the time is correct. If you have made a change the message 'TIME SAVED' will show, followed quickly by 'DATE + TIME COMPLETE'.
- c. Move the slider to the **RUN** position, to complete changing the time.

What do I do when the clocks go back in October and forward in March?

Your programmer is factory-set to adjust the clock automatically at the correct dates, so you should never need to adjust the clock forward or backwards yourself. It is possible to disable this particular feature, as described in the section '**Changing the Installer Parameters**' (See Page 14). You may also check the section '**Configuration and Service Data**' (See Page 16) to see how your Installer has configured your product.

What should I do if I get 'lost' while programming the programmer?

The Electronic Display on the programmer will provide you with help and tips to work through the programming. Should you ever get 'lost, the simplest thing to do is to

move the slider to the **RUN** position, and then move it back to the appropriate programming position where you got lost. At this point just follow the instructions again.

What happens if there is a power failure?

In the event of a mains power failure, the programmer display will go blank, the indicator lamps will go out, and the control outputs will switch off. All programmes and settings are stored in a special memory (call NV memory) which requires no power to maintain information, and so will be retained indefinitely.

On resumption of the power supply, the program selection will always revert to the 'AUTO' setting irrespective of whether 'OFF', 'ONCE' or 'CONSTANT' had previously been chosen.

We recommend that during longer absence from home, you should turn the cooker and/or boiler thermostats to the 'OFF' position if you want to ensure that the appliance remains OFF.

However, the date and time will be lost and will require re-setting.

Should the correct time and date ever be lost, for whatever reason, the message 'SET DATE + TIME' will be displayed whilst the slider is in the **RUN** position. In this case, simply follow the procedure under '**Step 1: Setting the Date and Time**' (see Page 9). It should not be necessary to make any changes to your programmes.

Troubleshooting Guide

This is a quick guide to help diagnose and cope with possible problems with the programmer. For further assistance, please contact your Installer.

| Symptom | Possible Cause | Remedy |
|---|---|---|
| The programmer has a blank LCD display | No power to the heating system | Check that there is power to the heating system |
| | Fault in Programmer | Call Installer |
| The programmer indicates that Heating and/or Cooker is ON , but radiators are cold and/or taps are running with cold water | Temperature controls are switched off or set to low | Check that the temperature controls in the system are set to appropriate levels |
| | Boiler or other system controls have malfunctioned | Call Installer |
| The programmer shows the message 'INTERNAL FAULT' | Fault in the programmer | Call Installer |

Configuration Data (to be completed by Installer)

The table below is for the Installer to complete to indicate how your Programmer has been configured.

| Configurable Features | Options | Installer Configured (tick appropriate box) |
|-------------------------------------|----------------------|---|
| 24 hr or am/pm clock display | am/pm display | <input type="checkbox"/> |
| | 24hr display | <input type="checkbox"/> |
| Display backlight operation | Off | <input type="checkbox"/> |
| | On if button pressed | <input type="checkbox"/> |
| | On continuously | <input type="checkbox"/> |
| Automatic time change | Enabled | <input type="checkbox"/> |
| | Disabled | <input type="checkbox"/> |
| 1-day or 5/2-day or 7-day operation | 1-day operation | <input type="checkbox"/> |
| | 5/2-day operation | <input type="checkbox"/> |
| | 7-day operation | <input type="checkbox"/> |
| Number of ON/OFFs per day | 2 on/offers per day | <input type="checkbox"/> |
| | 3 on/offers per day | <input type="checkbox"/> |
| Default programme | A = standard | <input type="checkbox"/> |
| | b = at home | <input type="checkbox"/> |
| | C = economy | <input type="checkbox"/> |

Cleaning and Care for your Rayburn

REMEMBER: BE CAREFUL OF THE HOT APPLIANCE.

DO NOT USE A STEAM CLEANER TO CLEAN THIS COOKER.

Enamelled Top Plate and Front Plate

- It is not advisable to put very wet clothes onto the handrail, as this may craze enamel.
- To keep the vitreous enamelled surface bright and clean, wipe over daily with a soapy damp cloth, followed by a clean dry cloth.
- Wipe off any condensation on the front plate as they occur or the vitreous enamel may be permanently discoloured.
- If milk or fruit juice or anything containing acid is split on the top plate or down the cooker, be sure to wipe it immediately or the vitreous enamel may be permanently discoloured.
- Keep a damp cloth handy while cooking, to wipe up spills as they occur, so they do not harden and become more difficult to remove later. Look for cleaners carrying the VEA (Vitreous Enamel Association) approval logo as this indicates they can be used on your Rayburn.
- For stubborn deposits, gentle localised soaking, not flooding is easier than rubbing and hot water and detergent will soften most burnt on stains in about 10 minutes.
- A soap impregnated pad can be carefully used on the vitreous enamel (look for VEA mark on suitable cleaners).

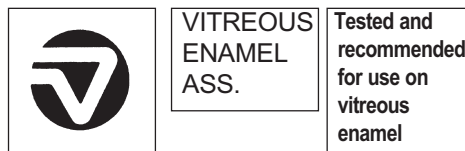

Important: AGA recommend Vitreous Enamel Association approved cleaners for cleaning the vitreous enamelled surfaces of this product.

But they are unsuitable for use on chrome and stainless steel components, including the hand-rails and their brackets.

The insulating covers should be cleaned regularly with a NON-ABRASIVE mild detergent, applied with a soft (coarse free) cloth and lightly polished up afterwards with a soft (coarse free) duster or tissue, to bring it back to its original lustre.

DO NOT USE ABRASIVE PADS, THAT ARE NOT VEA APPROVED, OVEN CLEANER, OR CLEANERS CONTAINING CITRIC ACID ON ENAMELLED SURFACES.

Oven Door Linings

- Using oven gloves carefully lift off the oven doors, lay them on a tea towel to protect the enamel. They can then be cleaned with a cream cleanser or soap impregnated pad. Do not however, immerse the doors in water as they are packed with insulating material which will be damaged by excessive moisture.

Insulating Lids

- **Chrome** Wipe over with a soapy damp cloth followed by a polish with a clean dry cloth.
- **Linings** The linings of the insulating lids may be cleaned with a cream cleanser or soap impregnated pad.

Ovens and Hotplate

- Use a wirebrush for cleaning the hotplate to remove burnt on spills.
- In the main oven spills and fat splashes are carbonised at high temperatures, occasionally brush out with a wire brush. Do not use oven cleaners.
- The Lower Oven should also be brushed or wiped out occasionally.

DO NOT USE ANY OVEN CLEANERS

Accessories

- Oven furniture such as Roasting Tins, Solid Plain shelves, Grid Shelves and Grill Racks should be cleaned in hot soapy water, soak if necessary, a nylon scouring pad can be used.

DO NOT PLACE IN THE DISHWASHER OR USE CAUSTIC CLEANERS.

BURNER RESET

Reset buttons in the plinth, under normal run conditions, flash every 15 seconds. This is part of the system monitoring.

If a fault occurs on either burner then it automatically shuts down and the red button on the burner control box will be illuminated. The reset button is located in the lower plinth panel.

OPERATE BY PRESSING WITH FINGER ONLY

Please wait at least 60 seconds between resetting the lockout button.

If for example the storage tank had been replenished after the oil supply ran out, and resetting the lockout button does not light the burner immediately, it will be necessary to repeat the sequence.

Continued lockouts indicate a burner or oil supply malfunction. The fault should be diagnosed and rectified.

In the event of repeated failure switch off the oil and electrical supply to the appliance and contact your installer/service engineer.

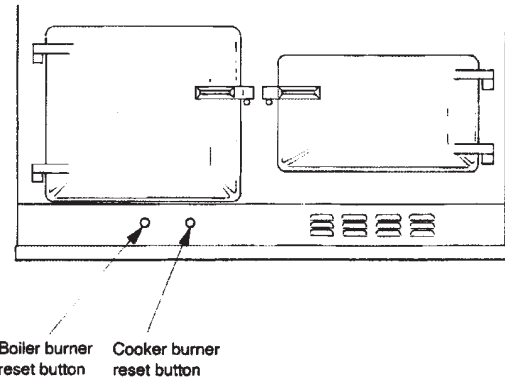

OIL LEAK OR FAULT

If an oil leak or fault exists or is suspected the unit must be isolated from the oil and electrical supply. The appliance must not be used until the fault has been rectified.

POWER FAILURE

In the event of power failure your appliance will become inoperative. When the power is restored it will automatically restart, if programmed or manually set to do so.

FUEL

Please endeavour to see that when your fuel is being delivered into your storage tank, that the appliance is left off during delivery, and preferably for a period of 1 hour afterwards to allow sediment within the tank to settle.

This is particularly important for oil systems using a two pipe flow and return.

Also endeavour to avoid running out of fuel, by seeing that the storage tank is replenished in good time. This will help avoid nuisance breakdowns which can result through fuel starvation.

VENTILATION

Please see that the permanent ventilation provided for the safe and reliable operation of your Rayburn is never blocked off.

DESN 511122

SERVICING

With normal use a boiler/cooker annual flueway clean and burner maintenance should be carried out immediately before the end of the heating season.

An additional flueway clean halfway through the season may be necessary in some cases - see servicing instructions .

A HOT APPLIANCE CANNOT BE SERVICED

Both cooker and boiler thermostat knobs should be turned OFF the night preceding the day of the servicing so that the appliance will have cooled down by the following morning.

For further advice or information contact your
local distributor/stockist

With AGA Rangemaster's policy of continuous
product improvement, the Company reserves the
right to change specifications and make
modifications to the appliance described at any
time.



from The word "from" is followed by the AGA logo, which consists of the letters "AGA" in a white, sans-serif font inside a black, horizontally-oriented oval with a metallic, brushed-metal border.

Manufactured by
AGA Rangemaster
Station Road
Ketley Telford
Shropshire TF1 5AQ
England

www.rayburn-web.co.uk
www.agaliving.com