



AGA Gas Fired Cooker Models GC and GE with AIMS



Users Instructions

PLEASE READ THESE INSTRUCTIONS BEFORE USING THIS APPLIANCE



03/10 EOP1 515931

CONTENTS

SECTION	PAGE
HEALTH AND SAFETY	3
THE AGA COOKER	4
HEAT INDICATOR	5
AUTOMATIC CONTROL	6
TO LIGHT THE BURNER	7
TO EXTINGUISH THE BURNER	7
POWER FAILURE	7
BURNER CONTROLS	8
OPERATING THE AGA	9
FITTING OF OVEN SHELVES	10
REMOVAL OF OVEN SHELVES	10
AIMS HANDSET	11
AIMS CONTROLS	12
AIMS SET-UP	12
AIMS CONTROLLER HANDSET	12 - 13
INFORMATION (MAIN MENU) SCREEN	14
SETTING DATE/TIME SCREEN	14
AIMS PROGRAMME SCREEN	15
HOLIDAY SCREEN	16
AIMS HANDSET CARE	17
CARING AND CLEANING	18
GUIDE TO AGA COOKING	19
SERVICING	20

HEALTH & SAFETY

Consumer Protection

As responsible manufacturers we take care to make sure that our products are designed and constructed to meet the required safety standards when properly installed and used.

This appliance is not intended for use by persons (including children) with reduced physical, sensory or mental capabilities, or lack of experience and knowledge, unless they have been given supervision or instruction concerning the use of the appliance by a person responsible for their safety.

Children should be supervised to ensure that they do not play with the appliance.

IMPORTANT NOTICE: PLEASE READ THE ACCOMPANYING WARRANTY

Any alteration that is not approved by AGA could invalidate the approval of the appliance, operation of the warranty and could also affect your statutory rights.

Important

This appliance may contain some of the materials that are indicated. It is the Users/Installers responsibility to ensure that the necessary personal protective clothing is worn when handling, where applicable, the pertinent parts that contain any of the listed materials that could be interpreted as being injurious to health and safety, see below for information.

Firebricks, Fuel Beds, Artificial Fuels - when handling use disposable gloves.

Fire Cement - when handling use disposable gloves.

Glues and Sealants - exercise caution - if these are still in liquid form use face mask and disposable gloves.

Glass Yarn, Mineral Wool, Insulation Pads, Ceramic Fibre, Kerosene Oil - may be harmful if inhaled, may be irritating to skin, eyes, nose and throat. When handling avoid inhaling and contact with skin or eyes. Use disposable gloves, face-masks and eye protection. After handling wash hands and other exposed parts. When disposing of the product, reduce dust with water spray, ensure that parts are securely wrapped.

THE AGA COOKER

Is a heat storage cooker with an automatic gas control, which will keep the temperature of the cooker constant when not in use and return it to the constant temperature after use.

Your AGA is supplied with the following accessories:

- 1 Large roasting tin with grill rack
- 1 Half-size roasting tin with grill rack
- 2 Oven Grid Shelves
- 1 Plain Shelf
- 1 Toaster
- 1 AGA Book
- 1 Wire Brush

In addition there is a guarantee registration card which should be completed and returned to AGA.

A full description of cooking with your AGA is given in the AGA Book.

For the most effective operation of the cooker the following points should be carefully observed:

1. Close the insulating lids whenever the hotplates are not in use.
2. Clean the hotplates regularly with the wire brush.
3. Utensils with ground flat bases must be used to make perfect contact with the hotplates.
4. Have the cooker serviced at regular intervals by your Authorised AGA Distributor.
5. Take care, when closing the oven doors, to left them on to the catch.

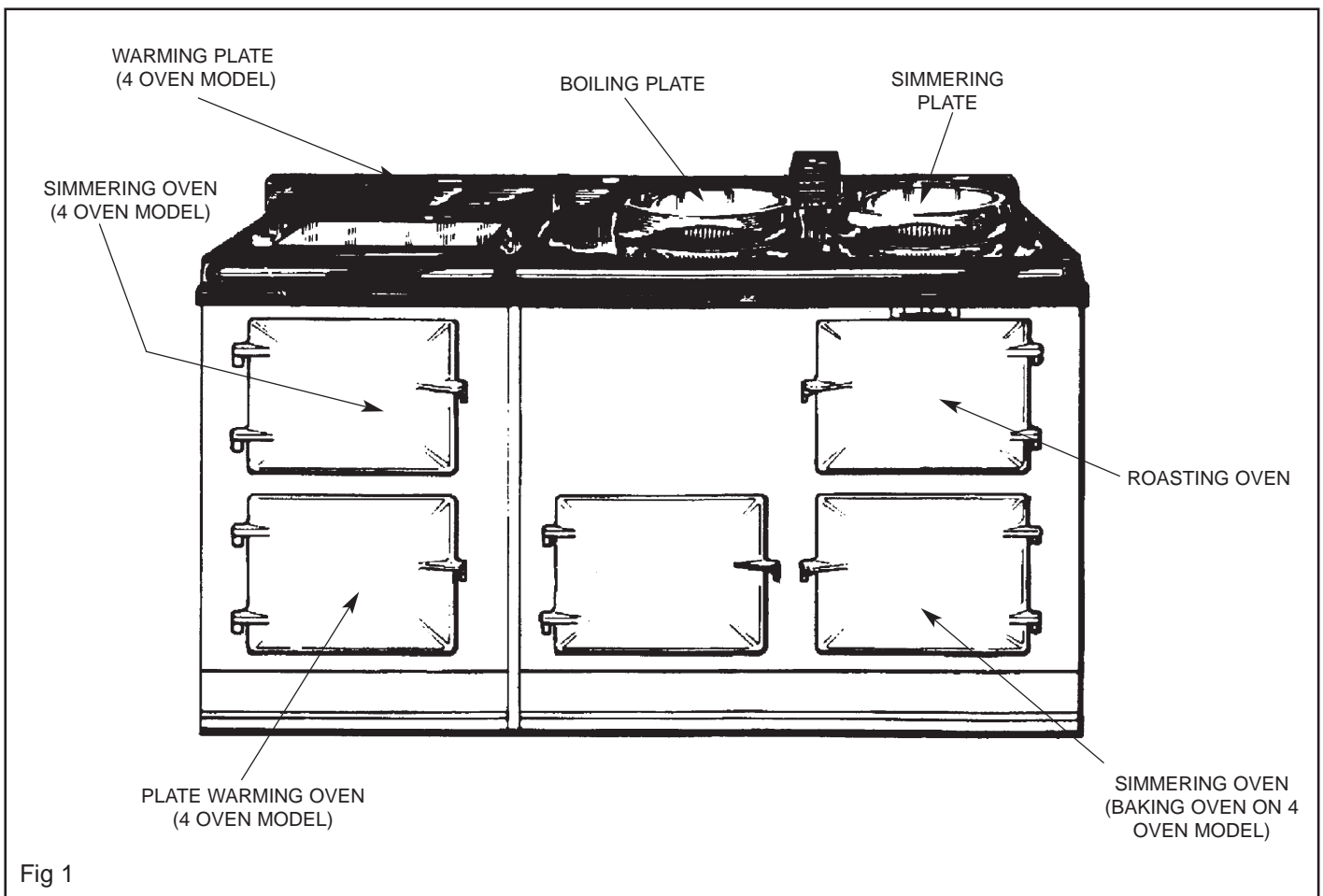
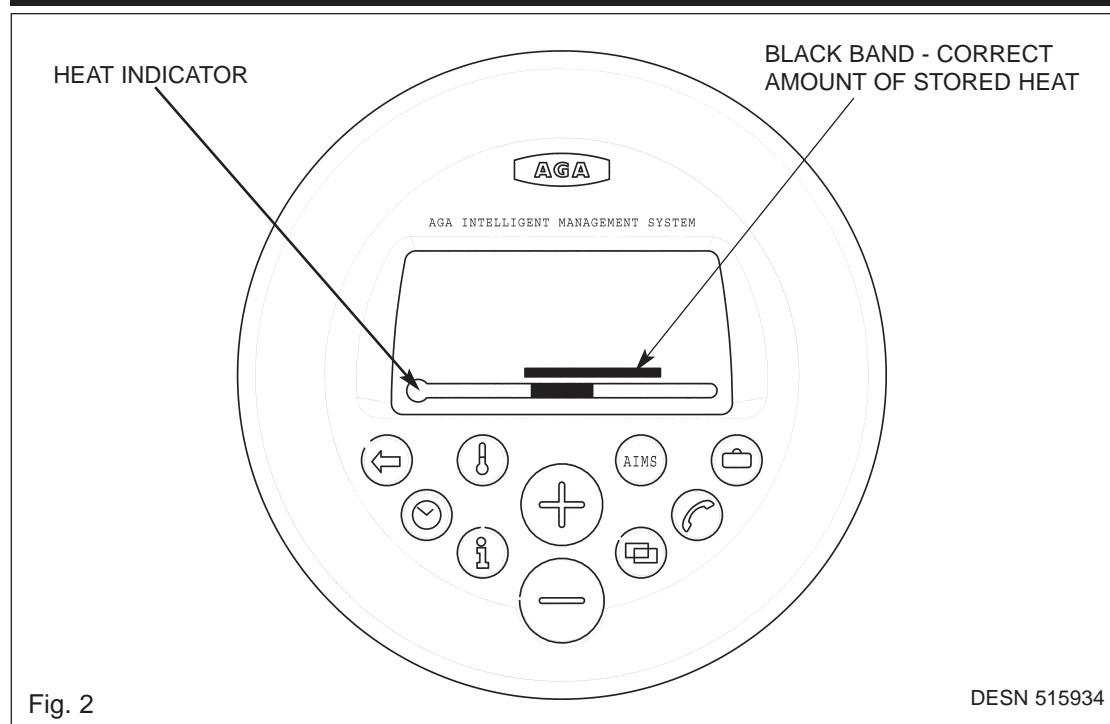

Fig 1

THE HEAT INDICATOR



The heat indicator is located on the AIMS handset 'INFORMATION SCREEN'. When the indicator is within the black band, the cooker is at the correct working temperature. The purpose of the heat indicator is to show whether the cooker contains the full amount of stored heat when the cooker is in normal operational mode.

During cooking the indicator band will drop back below the band. This is normal and the heat will be automatically restored, this could take up to 2 hours depending on the amount of use.

Also during AIMS 'LOW' and 'SLUMBER' setting the indicator will drop back outside of the black band.

AUTOMATIC CONTROL

When the cooker is in use the temperature control knob should be in the mid section of the green band, with the indicator within the black band on the AIMS handset. It may be necessary to adjust the control knob slightly within the green band to achieve this.

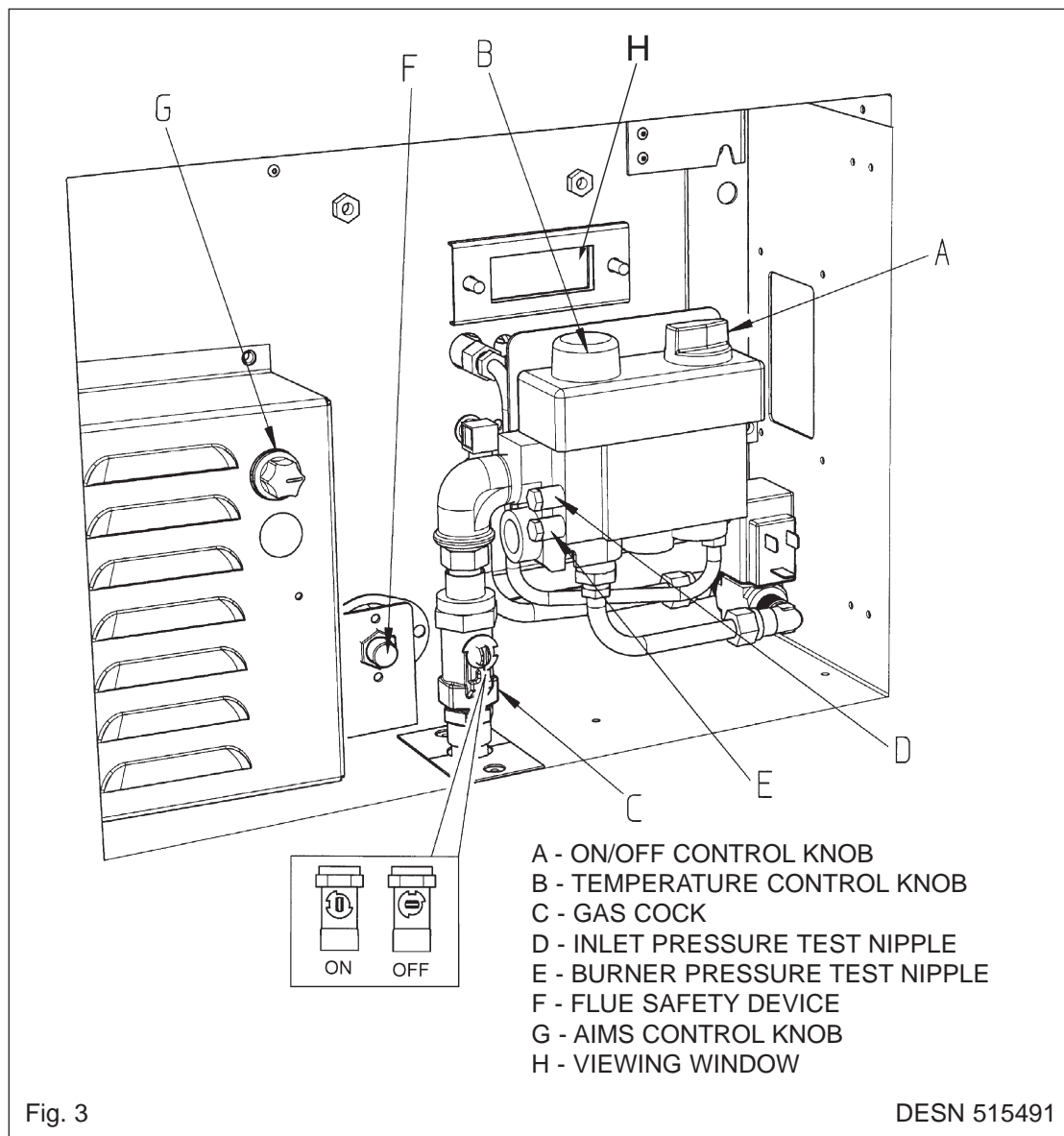

Fig. 3

DESN 515491

TO LIGHT THE BURNER

CAUTION: BEFORE LIGHTING: ENSURE KNOB (A) IS IN THE OFF POSITION (SEE FIG. 5). ALSO ENSURE GAS SUPPLY TO COOKER IS ON, AND THE GAS SERVICE COCK (C) IS IN THE ON POSITION (SEE FIG. 3), AND THE ELECTRICITY SUPPLY TO THE AGA IS SWITCHED ON.

LIGHTING PROCEDURE - SEE FIGS. 4 - 10

1. The main burner gas flow is set with the 'temperature' knob (B) (See Fig. 4). First, ensure both knobs are turned fully clockwise. Knob (A) to the OFF position and knob (B) to the minimum setting (See Fig. 4).
2. Turn ON/OFF knob (A) slightly anti-clockwise towards the IGNITION position (☞) until reaching stop, press down and hold for 5 seconds (gas flows only to the pilot burner). (See Fig. 6).
3. Continue pressing down knob (A) while turning further anti-clockwise to the PILOT position (this activates the piezo), continue to hold down for 10 seconds after pilot burner has been lit. (If the pilot does not light, steps 2 and 3 can be repeated). (See Fig. 7).
4. Upon lighting, release knob and turn further anti-clockwise to the ON position (large flame symbol) (See Fig. 8). Pilot gas flows and mains gas flows according to the temperature setting (knob B).
5. Turn the temperature knob (B) slightly anti-clockwise into the white band (LOW FIRE position). Leave in the low fire position for at least 30 minutes (See Fig. 9).

NOTE: 'LOW FIRE' position is attained by turning knob (B) gradually into the white band, until SMALL FLAME is observed through viewing window (H). (See Fig. 3).

6. After 30 minutes rotate control knob (B) anti-clockwise to the mid-position of the green band for normal running. (See Fig. 10).

NOTE: After several hours the heat indicator should be within the black band on the AIMS handset 'INFORMATION' screen. It may be necessary to adjust the control knob slightly in the green band to achieve this, allow the cooker to stabilise for at least 4 hours before attempting any further adjustment.

When the cooker is lit from cold, moisture may form on the enamel which should be wiped off to prevent staining.

IF THE FLAME HAS EXTINGUISHED FOR WHATEVER REASON, WAIT THREE MINUTES (MINIMUM) BEFORE RE-LIGHTING.

NOTE: IF THE PILOT EXTINGUISHES

For safety purposes a flue safety device (6) is fitted.

This will only operate in adverse flue conditions, it should be checked and if necessary depressed. If this problem persists contact your local engineer to determine and rectify the cause.

TO EXTINGUISH THE BURNER

1. Turn ON/OFF knob (A) clockwise until reaching stop (PILOT) position.
2. Press down slightly and continue turning clockwise from pilot position to the OFF position (See Fig. 5).

NOTE: LPG APPLIANCE ONLY. When the cooker is turned off a noticeably loud pop will be heard. This is quite normal.

When the burner has cooled sufficiently, pilot lighting procedure may be repeated.

POWER FAILURE (OPEN FLUE MODELS ONLY)

In the event of a power failure, the AIMS controls will not work until the power is restored. You can still use your appliance as a conventional AGA.

BURNER CONTROLS

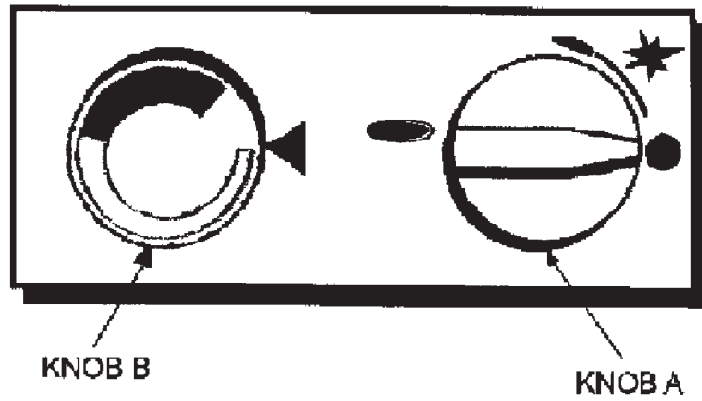
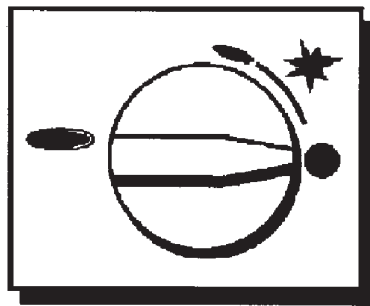

Fig. 4



OFF POSITION

Fig. 5



IGNITION POSITION

Fig. 6



PILOT POSITION

Fig. 7

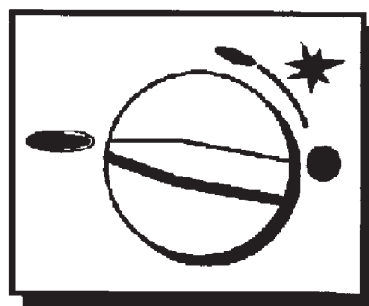

ON POSITION

Fig. 8

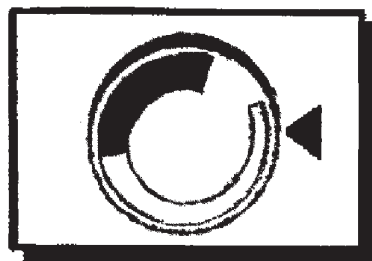

LOW FIRE

Fig. 9



NORMAL RUNNING

Fig. 10

OPERATING THE AGA

The following points are intended to help during the change-over from your previous cooker to the AGA way of life. You will also find that the AGA Book and the AGA new user guide video provide a very useful introduction to the cooker.

After the AGA has been installed

When first lit, the AGA will emit an odour for a short while. Do not worry, this is simply due to protective oil burning off the hotplates. If you can wipe the inside of the hotplate whilst the AGA is heating up it will avoid a film of this oil being deposited on the inside of the lids. Also, condensation may occur on the top plate and front plate whilst the AGA is heating up. This should be wiped away as soon as possible.

Beginning to Cook on your AGA

The first "Golden Rule" of the AGA is to cook as much as possible in the ovens - without changing your menus. This not only conserves the heat but also reduces cooking smells and condensation into the kitchen.

The Roasting Oven can also be used for grilling (at the top) and shallow frying (at the bottom). Do keep the insulated lids down when the hotplates are not in use so that the heat stored in the cooker is conserved.

For optimum cooking performance, use the AGA cast iron cookware.

They all have thick ground bases which give the best contact with the hotplates.

The AGA pans can be stacked in the Simmering Oven. This is especially useful for steaming vegetables and simmering sauces.

Store the Plain Shelf out of the AGA. Use it from cold in the Roasting Oven on a 2 oven AGA to deflect the heat from the top of the oven thus creating a more moderate oven temperature. It can also be used as a baking sheet.

The Aga Cake Baker can be used in the 2 oven AGA for cakes needing over 45 minutes cooking. A guide to AGA cooking is given on Page 19. Ask your Specialist for an invitation to an AGA demonstration.

FITTING OF OVEN SHELVES

When using the oven shelves for the first time follow Figs. 11 - 14.

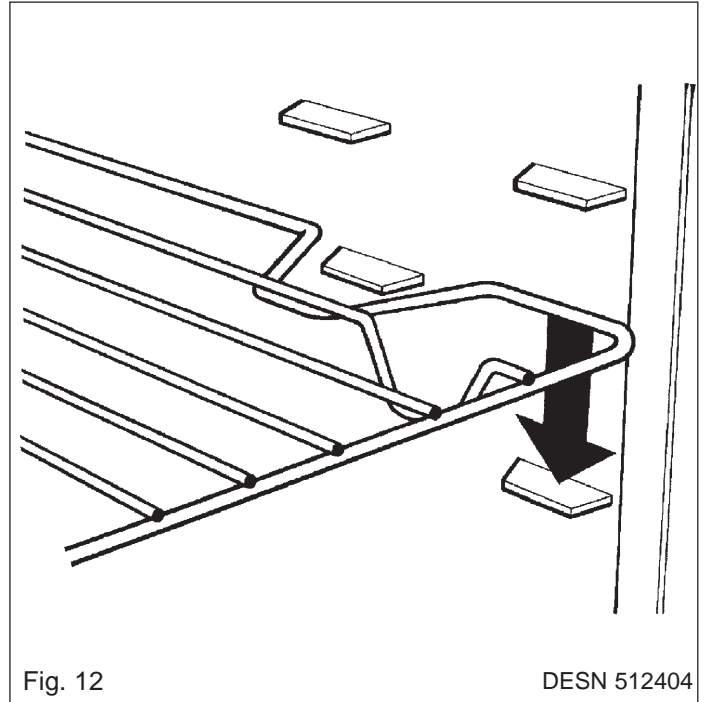
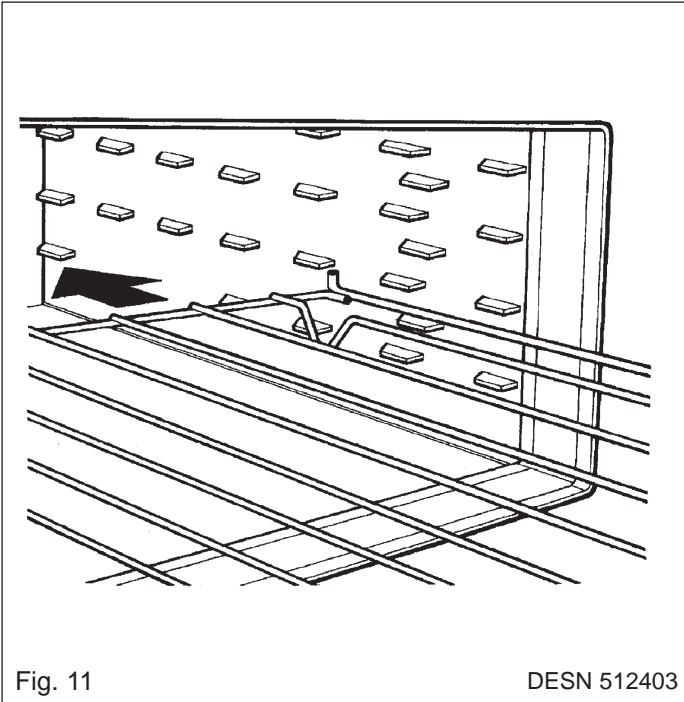

REMOVAL OF OVEN SHELVES

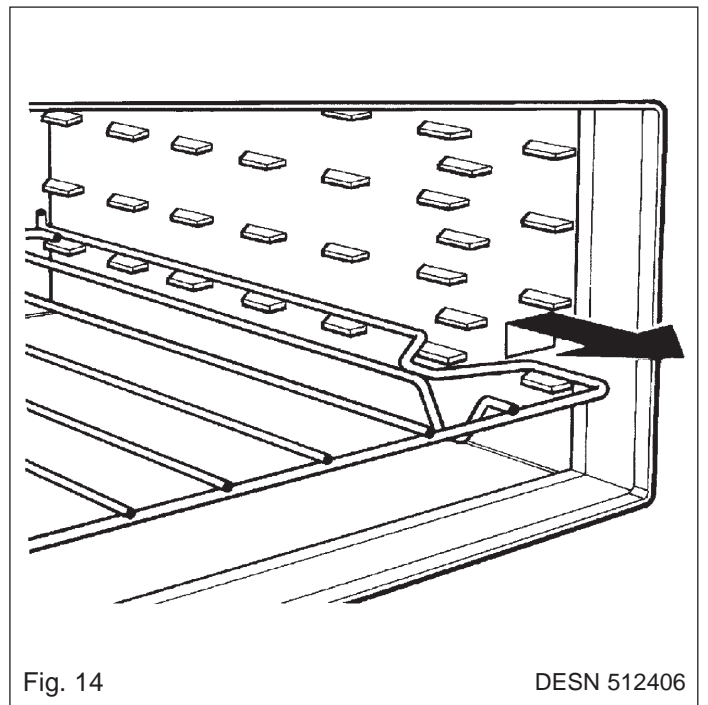
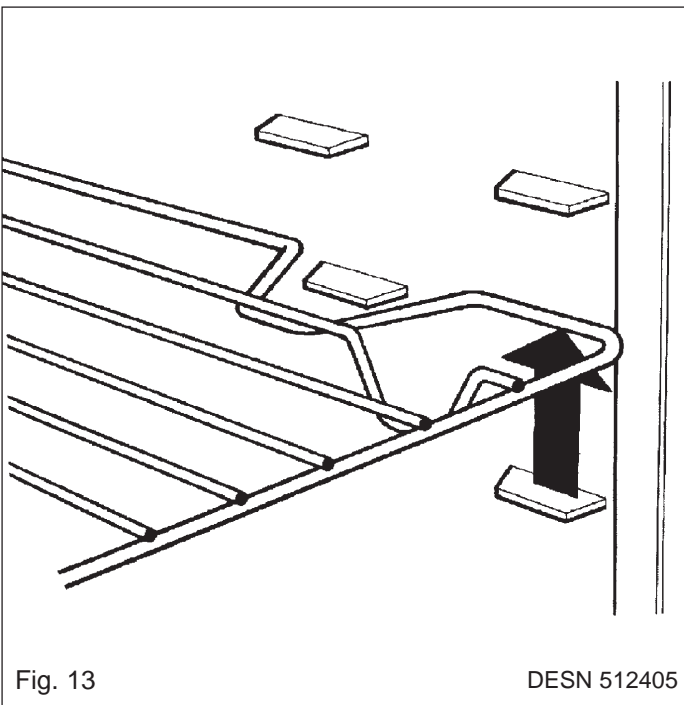

AIMS HANDSET

AIMS is a sophisticated program, which allows you to adjust the temperature of your AGA to suit your household lifestyle. It is supplied pre-set with two active 'Normal' periods each day. In this mode the AGA will be at normal temperature to cook breakfast in the morning, drop to a lower temperature during the day then back to normal temperature to prepare dinner in the evening. After dinner the temperature goes to 'Slumber' mode for overnight. The pre-settings can be adjusted, see following pages.

Handset can be wall mounted as described below.

- Remove backplate from the rear of the Handset by sliding down with hand and away from the Handset (See Fig. 15).
- Select the site for the handset and use the backplate to mark the position of fixing holes. Avoid mounting handset on the wall behind the AGA.
- Drill 6mm dia. holes with masonry drill for the rawplugs.
- Use rawplugs and screws supplied to fix the backplate to the wall (See Fig. 16).
- Stick the round self adhesive label supplied to the inside of the backplate to cover the fixing screw heads.
- Fit the Handset on to the backplate by locating the tag on to the slot in backplate as shown (See Fig. 17).

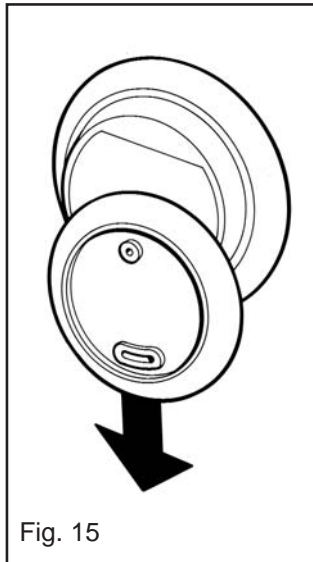

Fig. 15

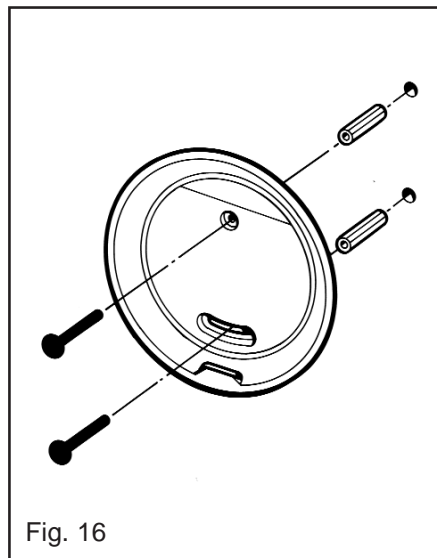

Fig. 16

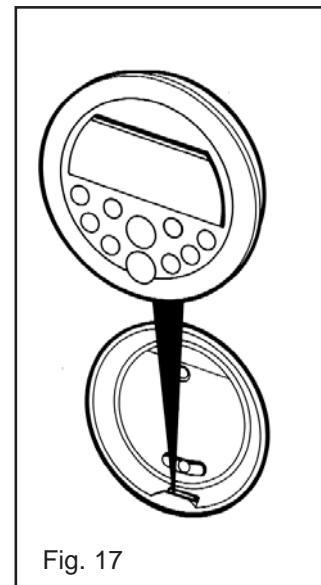

Fig. 17

AIMS (AGA INTELLIGENT MANAGEMENT SYSTEM)



CONTROLS



Fig. 18

DESN 515484

AIMS SET-UP

1. Connect the electricity supply and the gas supply.
2. Set the control knob on the base unit to manual  (See Fig. 18)
3. To light the burner follow the lighting procedure (See Pages 7 - 8).
4. It is recommended that the cooker is run on the  Normal Manual setting for two days, before switching to AIMS (automatic control).
5. When the normal temperature has been set within the black band, it should not be necessary to alter the temperature control again.
REMEMBER: If adjustment is made to leave the cooker to stabilise for at least 4 hours before attempting further adjustment.
6. The cooker can now be switched to AIMS (automatic control), by turning the control knob from the Manual setting to the AIMS setting.
7. The AIMS hand set can then be used to programme the required settings (see AIMS automatic control) instructions.

AIMS CONTROLLER HANDSET

The handset is designed to operate within the kitchen area.

When transferring information from or to the controller always operate the handset in front of the cooker, this gives the strongest communication signal.

If the handset indicates 'OFFLINE', press the back button  firmly, this will activate the communication link between the cooker and handset.

Should the handset continue to show 'OFFLINE', allow one minute for the handset to "automatically" reconnect itself with the cooker.

The handset has 10 buttons and a display screen.

NOTE: If the AIMS handset is unused for an extended period of time, the display screen will automatically turn OFF to conserve battery power. The controller is designed to be operated within the kitchen area.

Press firmly any button on the handset to turn the display back on, and the Information (main menu) screen is automatically displayed.

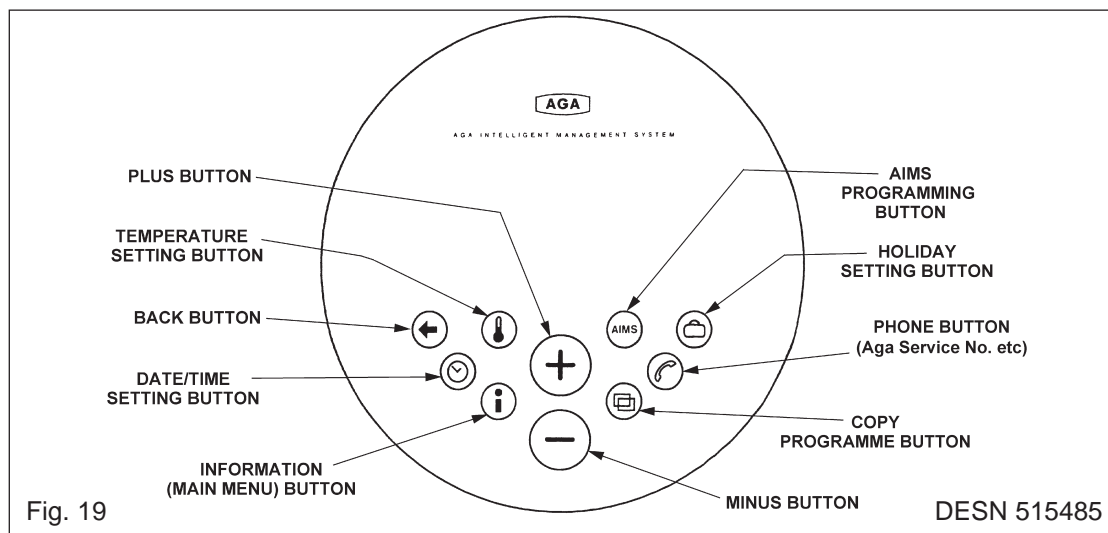

The AIMS Controller handset has four display screens:

1. The Information (main menu) screen
2. The Date/Time setting screen
3. The AIMS Programme Screen
4. The Holiday Setting Screen

See each section for details:

The AIMS has one or two programmable events:

The two events programme will enable the AGA to be at 'Normal' in the morning, (ie to cook breakfast) drop to a lower temperature during the day, and return to 'Normal' temperature in the evening (ie: to cook dinner) and drop to 'Slumber' later in the evening and throughout the night.

The one event programme will enable the AGA to drop to 'Slumber' during the night and return to 'Normal' throughout the day.

This will be shown as Once or Twice on the AIMS programme screen. (See Fig. 22).

The 'Normal' temperature for those two events is set beforehand using the cooker thermostat, see AIMS set-up.

The modes in between the events can be set at 'Low' or 'Slumber' depending on personal preference.

If a mistake is made when setting the date or time on any of the screens, use the back button  to go back to the previous setting.

The phone button can be used to store a useful phone number.

Press the  button to activate.

Press the  button to move between settings.

Press + or - to alter letter/number.

Press the  button to confirm setting.

Once the name and number have been set, scroll to end of the number until the display goes back to the information screen (using the  button).

Press  again to confirm name and number have been entered.

SELECTING HANDSET LANGUAGE

Language options are selected during the **Handset to Base Unit Signal Check/Language Selection Procedure**, see page 17.

INFORMATION (MAIN MENU) SCREEN

Press the  button to activate this screen

Indicates that the cooker is operating automatically (AIMS) or manually (according to switch position on main Aga control panel)

This indicates the current cooker mode, (Normal, Low or Slumber). If an arrow is showing → this indicates the cooker is heating up from Low or Slumber to Normal.

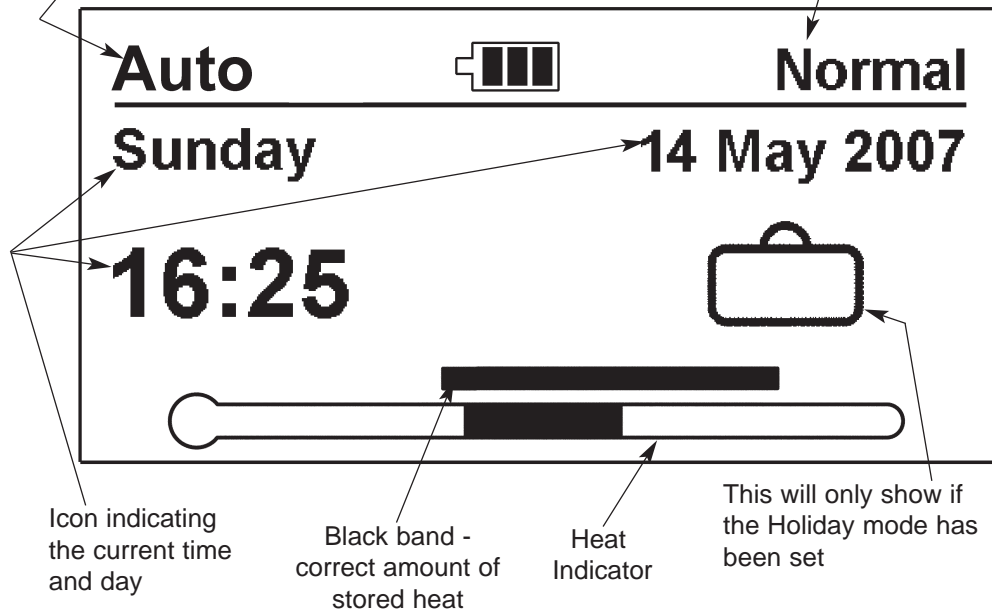





Fig. 19

DESN 515488 A

THE SETTINGS DATE/TIME SCREEN

Press the  button to activate this screen

1. Press the  button to move between the date and time.
2. Press + or - to alter date and time settings.
3. Press the  button to confirm the settings and move to the next action

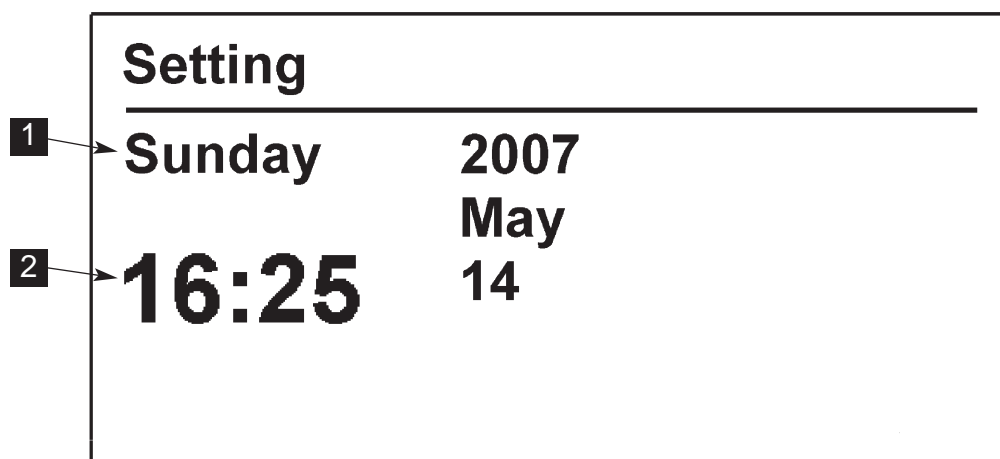











Fig. 21

DESN 515273



AIMS PROGRAMME SCREEN

Use the  button to activate this screen and to move through the different actions and set an AIMS programme. To go back a step at any time press .

1. Set the frequency of the programme Once or Twice daily using + and - buttons.
2. Press  button to select start time for 'Normal' setting then use the + or - buttons to set start time. When a time is selected it will be highlighted in dark blue.
3. Press the  button to select finish time then use + and - buttons to set finish time. When a time is selected it will be highlighted in dark blue.
4. Press the  button then press the  button to alter the temperature setting to 'Low', 'Slumber', or 'Off'. (Repeat steps 2 - 4 to set a 2nd event)
To copy this days settings for the next day press the  button or alternatively press the  button to enter different settings for next day.

Each push of the copy button steps onto next day. When the desired days have been programmed a return must be made to the main menu screen by pressing the  button. A "Save Changes" message will be displayed. Press  to confirm, "Message Sent OK" will then display to confirm changes have been sent to base unit.

If the programme is not set for the whole week the programme for the remaining days will revert to a default setting. ie: 7:00 am - 10:00 am and 16:00 - 19:00.

To change a setting within the AIMS program, press the  button until the desired setting is reached. Then change setting using either the +, - or  buttons as appropriate.

If no other changes are to be made, push the  button to transmit the change (s) and return to main menu. A message saying '**Message Sent OK**' will display, indicating that the changes are being transmitted to the base unit. Unless this shows, the changes will not have been implemented.

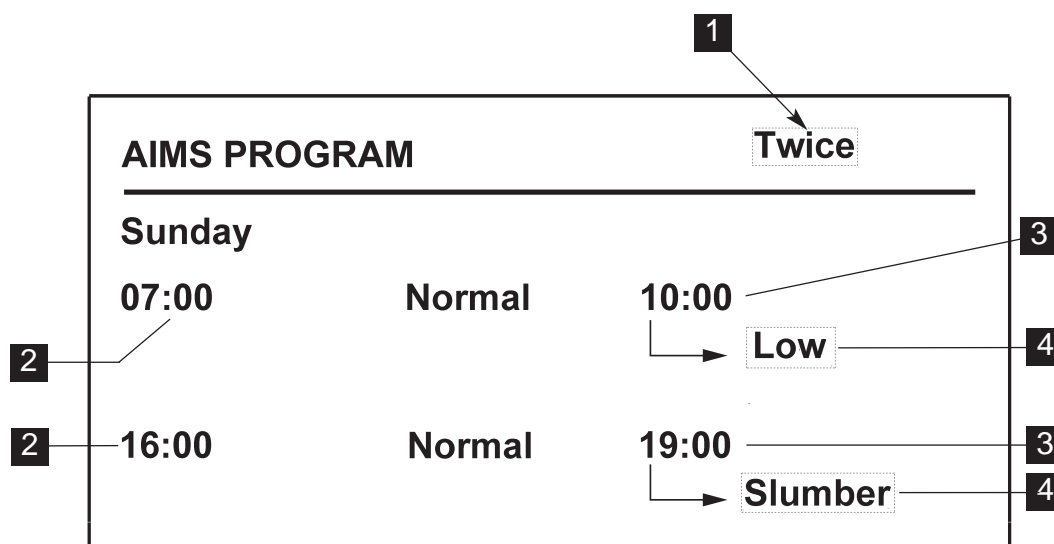



Fig. 22

DESN 515274

This screen shows that the ovens will be up at 'Normal' temperature between 07:00 and 10:00 the ovens will then go to the 'Low' mode.





The ovens will come up to 'Normal' once more in that day i.e. at 16:00 until 19:00. After the evening the system will automatically enter 'Slumber' mode its lowest setting until next morning.

Boost

If cooking is required when the Aga is in the **AIMS** programme i.e 'Low' or 'Slumber', you can boost the cooking temperature by pressing the  Button which will bring the AGA upto 'Normal' operating temperature. This will take up to 2 hours from 'Low' and 4 hours from 'Slumber'. To cancel press  button again.

THE HOLIDAY SCREEN

Press the  button to activate this screen and to move through the different operations and set a holiday programme.

1. Set a start date and time using the + or - buttons. Pressing the  button after each field has been entered to move you to the next field.
When a field is selected it will be highlighted in dark blue.
2. Set an end date and time using the + or - buttons. Pressing the  button after each field has been entered to move you to the next field.
3. Press the  button to alter the temperature setting to 'Low', 'Slumber' or 'Off'
When all the settings are completed press the  button again to enable the Holiday programme.
The display will return to the Main Menu Screen.

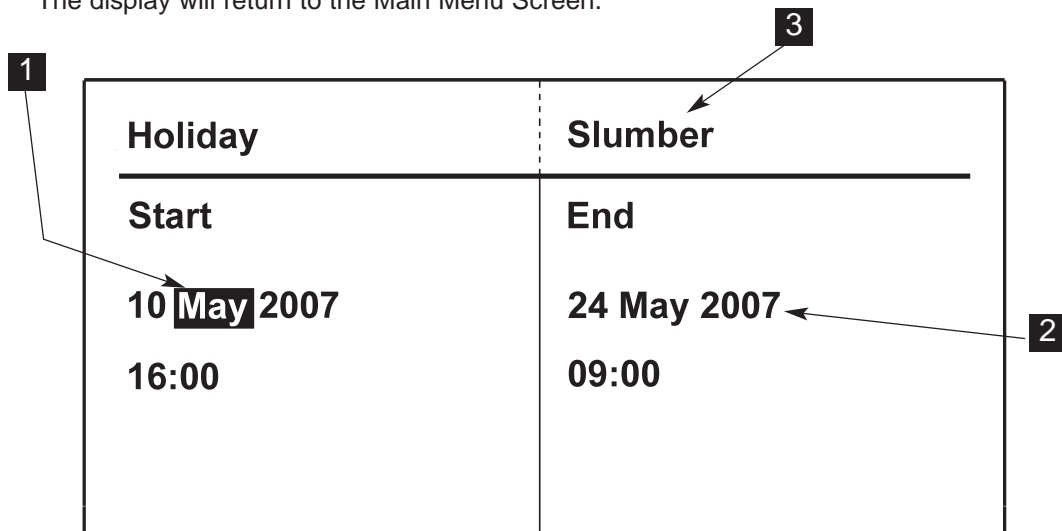

Fig. 23



DESN 515275

Once a holiday mode has been set it will show as 'Holiday Enabled' on the main menu screen.

If you wish to cancel the holiday setting:

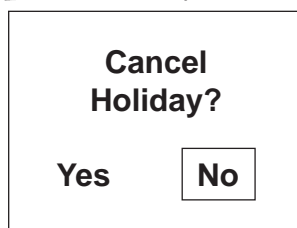
Press the  button, then press the  button and the following screen will appear:



Highlight YES using the  button, press the  button to return to main menu screen.

If you wish to alter a holiday setting:-

Press , alter setting (use + or - then ), then after last setting press  again to return to main menu screen.

In event of a power cut

If mains power is lost/or disconnected for more than 15 minutes, when the power is restored the handset will display:-

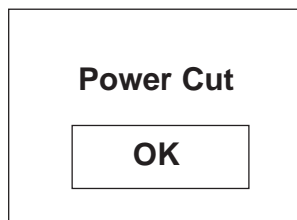

By then pressing the  button, this will send the correct time/date settings to the base.

AIMS HANDSET CARE

Operating Distance

The Handset will only operate in the same room as the appliance and up to a maximum distance of 4 metres from the appliance. If out of recommended operating range, the handset may show "OFFLINE". Move handset back to within the recommended distance and the handset should correct itself. See note at foot of this page for "Handset to Base Unit Signal Check".

Cleaning

The Handset should be wiped clean using a soft clean cloth.

Do not use abrasive cleaning products or submerge the Handset in water.

Batteries

The Handset is fitted with four 'AAA' batteries.

Batteries life will depend on usages.

Replace the batteries when the battery symbol on the Handset is down to one bar following the instructions below.

- Remove the Handset from the backplate.
- Remove the battery cover plate from the rear of the Handset. (See Fig. 24)
- Carefully lever out the batteries commencing with the bottom one first pushing and pulling out on the **positive (+) end only**. (See Fig. 25)
- Repeat the procedure to remove the other batteries.
- **Always** use long life batteries for replacements.
- Replace batteries commencing with the bottom one working to the top (See Fig. 26). Ensure that the negative (-) end of the batteries is under the location pegs in the housing before pushing the other end into position.

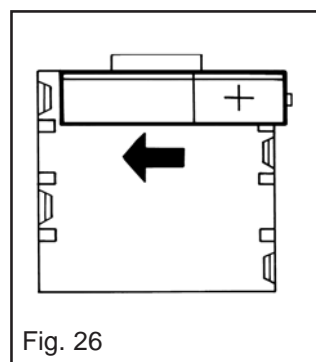
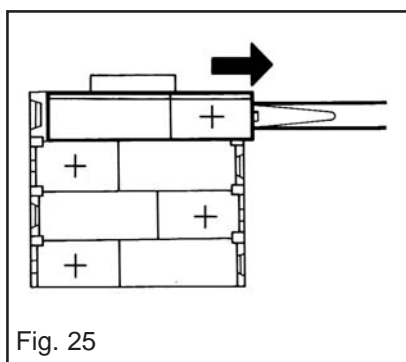
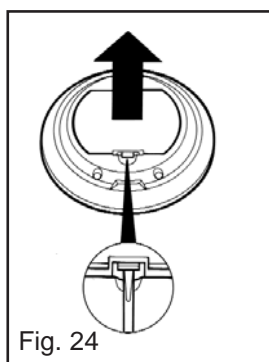

Handset Failure

In the event of Handset failure, the appliance would still be operational with the last selected programme. The appliance can also be changed to manual mode if required using the control knob (see fig 12).

If the Handset is damaged or lost, replacement can be obtained from AGA and re-programmed to suit your appliance.

Handset to Base Unit Signal Check/Language Selection

Complete the following procedure to check the handset is communicating with the base unit and select a language option.

1. Switch on the power supply to the cooker. Immediately, switch the control knob on the base unit back and forth between manual and AIMS setting until the blue neon flashes.
2. Immediately after neon starts to flash press and hold the + and - buttons together on the handset until the blue neon goes out completely (handset display will briefly say 'SERIAL NUMBER FOUND', then release buttons.
3. If the neon does not extinguish completely, but continues to flash with faint output, then repeat steps 1 and 2 above.
4. When the connection has been made, the screen will display the language options, use the + or - buttons to scroll through the options to the desired language, then press the  button to confirm selection.
5. If the language options need to be changed at any time then the whole procedure must be repeated from step 1.

CARING AND CLEANING

REMEMBER: BE CAREFUL OF THE HOT APPLIANCE.

DO NOT USE A STEAM CLEANER TO CLEAN THIS COOKER.

DO NOT USE ABRASIVE PADS OR OVEN CLEANERS.

Top Plate and Front Plate

The easiest way to clean the AGA top plate and front plate is to mop up spills as soon as they happen. Baked-on food is more difficult to clean but can usually be removed with the AGA vitreous enamel cleaner or mild cream cleaners using a damp cloth, or, if necessary a nylon scouring pad. If milk or fruit juice or anything containing acid, is spilt on the AGA, wipe it up immediately. Also clean off any condensation streaks on the front plate around the oven doors or the vitreous enamel maybe permanently discoloured.

All that is usually needed to keep the vitreous enamel surfaces of the AGA bright and clean is a daily rub over with a damp soapy cloth followed immediately with a clean, dry cloth to avoid streaks.

Remember the top plate and the polished covers will scratch if pans or utensils are dragged across them.

Insulating Covers and Oven Doors

The linings of the insulating Covers and oven doors may be cleaned with a cream cleanser or a soap impregnated pad.

Open the covers and lift off the oven doors to allow them to cool a little before cleaning. Do not, however, immerse the doors in water as they are packed with insulating material which will be damaged by excessive moisture.

Refer also to the Cleaning Section in The AGA Book.

Ovens and Hotplates

The cast iron ovens help to keep themselves clean, they merely need to be brushed out occasionally with a long handled stiff brush.

The wire brush is provided for cleaning the hotplate and any burnt on spills in the cast iron ovens.

Roasting Tins

The enamelled roasting tins supplied with the new AGA should be cleaned in hot soapy water, soaking if necessary. A nylon scouring pad can also be used. They may also be cleaned in the dishwasher but, with constant use, the enamelled finish will become dull in appearance.

DO NOT use caustic cleaners or oven cleaners.

Important: AGA recommend Vitreous Enamel Association approved cleaners for cleaning the vitreous enamelled surfaces of this product.

They are unsuitable for use on: chrome and stainless steel components, including the insulating covers, hand-rails and their brackets.

The insulating covers should be cleaned regularly with a NON-ABRASIVE mild detergent, applied with a soft (coarse free) cloth and lightly polished up afterwards with a soft (coarse free) duster or tissue, to bring it back to its original lustre.

GUIDE TO AGA COOKING

As the AGA Cooker is heated differently from an ordinary cooker, exact conversions are not possible. Look in the Aga Book for a similar recipe. Below is a quick guide to oven usage.

OVEN TEMPERATURE	2=TWO OVEN AGA	=4=FOUR OVEN AGA
HIGH	ROASTING OVEN	ROASTING OVEN
GRILLING SCONES PASTRIES BREAD YORKSHIRE PUDDING ROASTS SHALLOW FRYING	Top - Grilling; 2nd runner - Scones, Small Pastries; 3rd runner - Bread Rolls, Yorkshire Pudding; 4th runner - Roasts, Poultry, Small Cakes in cases in the large meat tin. Grid shelf on oven floor - Loaves. Oven floor - Shallow frying. Quiche.	Top - Grilling; 2nd runner - Scones, Small Pastries; 3rd runner - Bread Rolls, Yorkshire Pudding; 4th Runner - Roasts, Poultry. Grid shelf on oven floor - Loaves Oven floor - Shallow frying, Quiche.
MODERATE	ROASTING/SIMMERING OVEN	BAKING OVEN
CAKES BISCUITS FISH SOUFFLÉS SHORTBREAD CHEESECAKES	Place grid shelf on floor of Roasting Oven. Protect food with the cold plain shelf slid on second or third runners. For cakes that require over 45 mins use the Cake Baker. Alternatively with fish, cheesecake, start off in Roasting Oven, finish in Simmering Oven.	Towards top - Whisked Sponges, Some Biscuits, Small Cakes Middle - Fish, Soufflés. Grid shelf on oven floor - Victoria Sandwiches, Shortbread and Cheesecake
LOW	SIMMERING OVEN	SIMMERING OVEN
CASSEROLES STOCK MILK PUDDINGS MERINGUES RICH FRUIT CAKE	For Casseroles, Stock, Milk Puddings, bring to heat elsewhere on the Aga then transfer to Simmering Oven. (One exception is Meringues). Rich Fruit Cakes can be cooked for a long time here	For Casseroles, Stock, Milk Puddings, bring to heat elsewhere on the AGA then transfer to Simmering Oven. (One exception is Meringues). Rich Fruit Cakes can be cooked for a long time here.

SERVICING

- In the event of your appliance requiring maintenance, please contact AGA Service or your AGA Specialist.
- Your cooker must only be serviced by a qualified engineer, from an authorised AGA Specialist.
- Do not alter or modify the cooker.
- Only the spares specified by the manufacturer, are to be fitted.

For continued efficient and safe operation of this part of the appliance, it is important that servicing is carried out at regular intervals as recommended by your AGA Specialist, once every 12 months. The cooker should be turned OFF by the user the night preceding the day of servicing so that the appliance will have cooled down by the following morning.

A HOT APPLIANCE CANNOT BE SERVICED.

For further advice or information contact your
local AGA Specialist

With AGA's policy of continuous product
improvement, the Company reserves the right to
change specifications and make modifications to
the appliance described and illustrated at any time.



Manufactured By
AGA
Station Road
Ketley Telford
Shropshire TF1 5AQ
England

www.aga-web.co.uk
www.agacookshop.co.uk
www.agalinks.com